

Herrajes

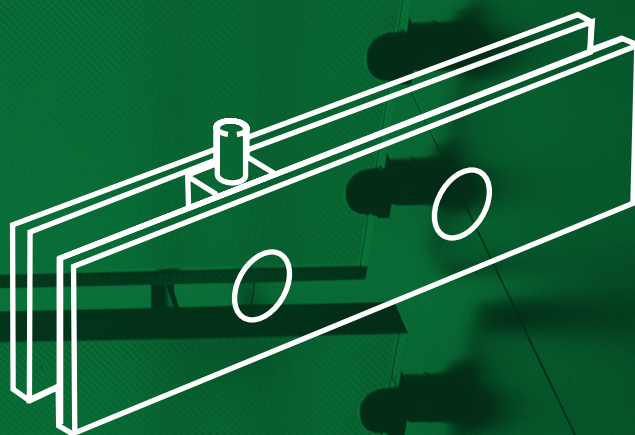

2.1 - SECURIT.....	102-132
2.2 - PERNIOS HIDRÁULICOS.....	133-138
2.3 - HERRAJES PARA CARPINTERÍA.....	139
2.4 - TOPES PARA VIDRIO Y CARPINTERÍA.....	140
2.5 - TOPES DE SUELO.....	141
2.6 - PLINTOS.....	142-143

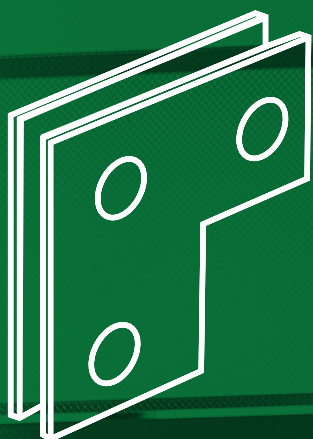

HERRAJES SERIE (CE)

Vidrio 10 mm

PERNIO ALTO 160 x 37 mm (CE)

Medida máxima puerta: 2500 x 1100 mm

Peso máximo puerta: 70 kg

Acabados:

Inox brillo	4140 IB
Inox mate	4140 IM

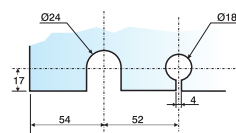
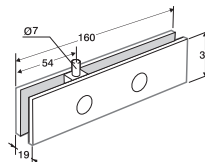
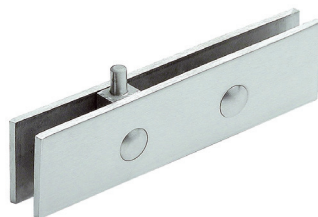

101N

PERNIO ALTO REFORZADO

160 x 37 mm (CE)

Acabados:

Inox brillo	4140.R IB
Inox mate	4140.R IM

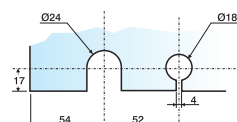
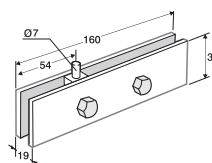
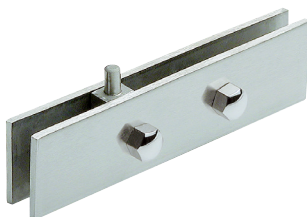

101NR

PERNIO BAJO

160 x 46 mm (CE)

Medida máxima puerta: 2500 x 1100 mm

Acabados:

Inox brillo	4141 IB
Inox mate	4141 IM

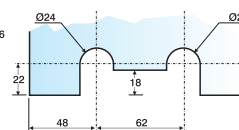
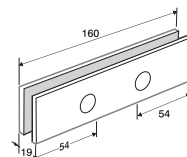

1032

PERNIO BAJO REFORZADO

160 x 50 mm (CE)

Acabados:

Inox brillo	4142 IB
Inox mate	4142 IM

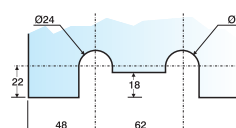
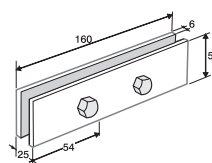

1032R

PERNIO ALTO PARA GIRO DESPLAZADO

148 x 37 mm

Acabados:

Inox brillo	4143 IB
Inox mate	4143 IM

*Indícanos la mano

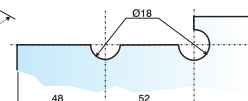
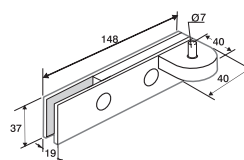

141N

PERNIO BAJO PARA GIRO DESPLAZADO

(Cuadradillo francés)

148 x 40 mm

Acabados:

Inox brillo	4144 IB
Inox mate	4144 IM

*Indícanos la mano

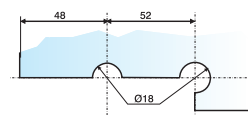
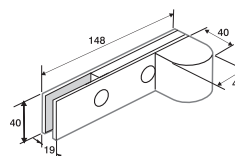
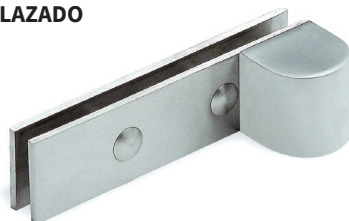

142N

PUNTO DE GIRO MONTANTE

162 x 40 mm (CE)

Acabados:

Inox brillo	4160 IB
Inox mate	4160 IM

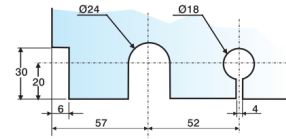
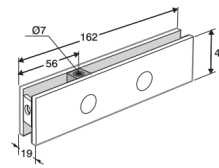

403N

PUNTO DE GIRO MONTANTE DESPLAZADO

160 x 40 mm (CE)

Acabados:

Inox brillo	4162.1 IB
Inox mate	4162.1 IM

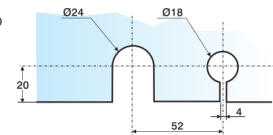
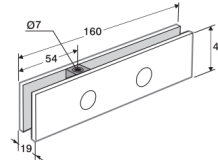

403N/2

PUNTO DE GIRO MONTANTE ALETA

162 x 40 mm (CE)

Acabados:

Inox brillo	4161 IB
Inox mate	4161 IM

*Indícanos la mano

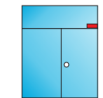
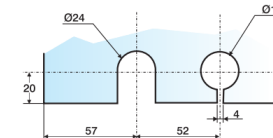
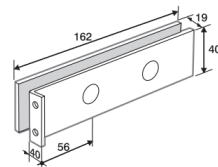

409N

PUNTO DE GIRO LATERAL MONTANTE EN BATERÍA DE PUERTAS

202 x 40 mm (CE)

Acabados:

Inox brillo	4162 IB
Inox mate	4162 IM

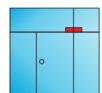
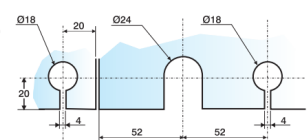
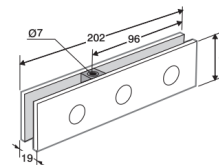

404N

PUNTO DE GIRO LATERAL MONTANTE CONTRAFUERTE

202 x 80 mm (CE)

Acabados:

Inox brillo	4163 IB
Inox mate	4163 IM

*Indícanos la mano

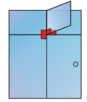
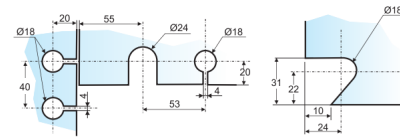
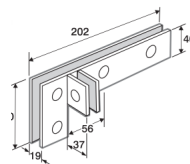
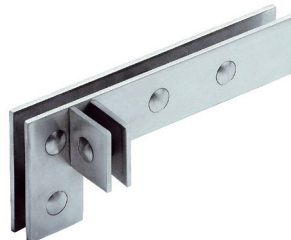

431N

PUNTO DE GIRO MONTANTE DOBLE

324 x 40 mm (CE)

Acabados:

Inox brillo	4164 IB
Inox mate	4164 IM

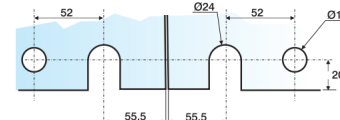
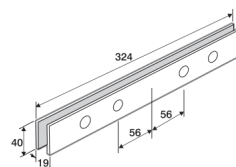

420N



Vidrio 10 mm

PUNTO DE GIRO LATERAL MONTANTE

202 x 80 mm (CE)

Acabados:

Inox brillo	4165 IB
Inox mate	4165 IM

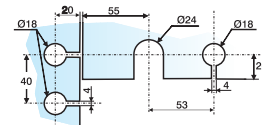
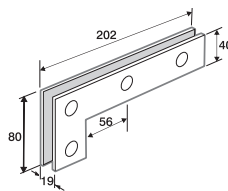

401N

90°

181 x 80 mm

Acabados:

Inox brillo	4165.1 IB
Inox mate	4165.1 IM

*Indícanos la mano

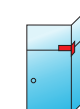
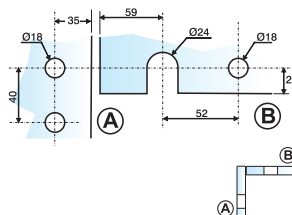
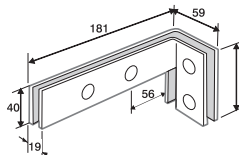

401N90°

401NVG

VARIACIÓN GRADOS

181 x 80 mm

Acabados:

Inox brillo	4165.2 IB
Inox mate	4165.2 IM

*Indícanos la mano

* Bajo pedido

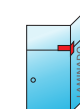
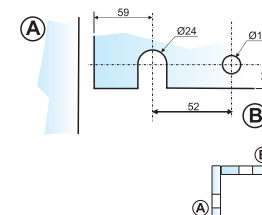
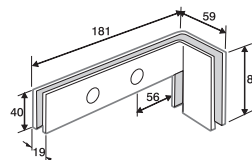

401NC90°

90° TALADROS CIEGOS

181 x 80 mm

Acabados:

Inox brillo	4165.5 IB
Inox mate	4165.5 IM

*Indícanos la mano

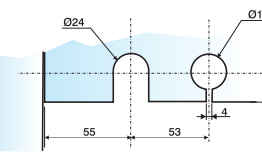
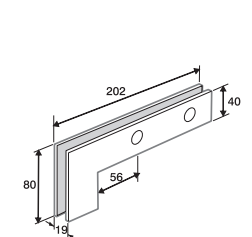

401NC

TALADROS CIEGOS

202 x 80 mm

Acabados:

Inox brillo	4165.3 IB
Inox mate	4165.3 IM

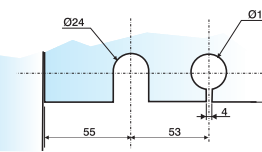
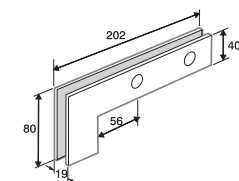

PUNTO DE GIRO MONTANTE PARED (CE)

Acabados:

Inox brillo	4161.1 IB
Inox mate	4161.1 IM

*Indícanos la mano

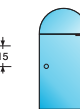
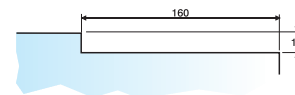
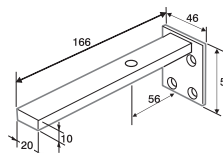
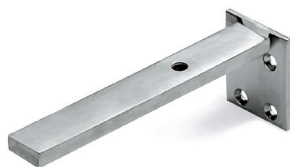

130N

PUNTO DE GIRO LATERAL MONTANTE DESPLAZADO

190 x 80 mm

(PARA 4143)

Acabados:

Inox brillo	4166 IB
Inox mate	4166 IM

*Indícanos la mano

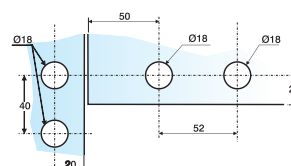
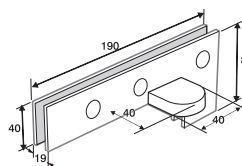

441N

PUNTO DE GIRO MONTANTE DESPLAZADO

150 x 40 mm

Para ref. 4143

Acabados:

Inox brillo	4167 IB
Inox mate	4167 IM

*Indícanos la mano

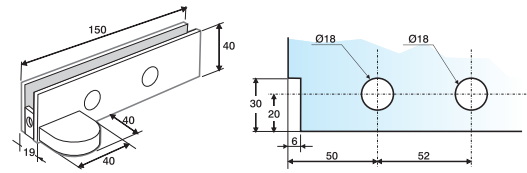

442N



PUNTO DE GIRO SUPERIOR A MARCO DESPLAZADO

Para ref. 4143

Acabados:

Inox brillo	4168.2 IB
Inox mate	4168.2 IM

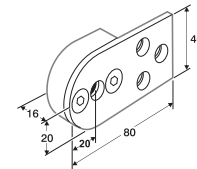

440N



PUNTO DE GIRO RECTANGULAR (CE)

89 x 25 mm

Para ref. 4140

Acabados:

Inox brillo	4168 IB
Inox mate	4168 IM

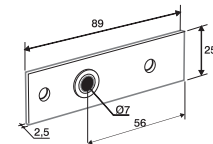
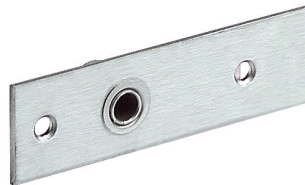

452N



PUNTO DE GIRO TECHILLO

Ø 32 mm

Para ref. 4140

Acabados:

Inox brillo	4069 IB
Inox mate	4069 IM

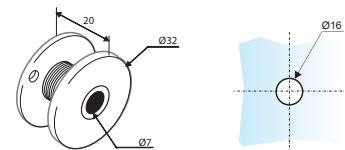

RCGT

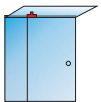

FIJO UNA LUNA (CE)

40 x 40 mm

Acabados:

Inox brillo	4172 IB
Inox mate	4172 IM

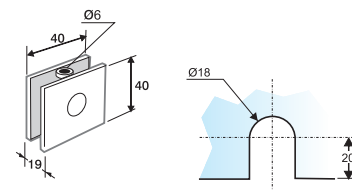

555S



FIJO UNA LUNA 40 x 40 mm (CE)

Acabados:

Inox brillo	4175 IB
Inox mate	4175 IM

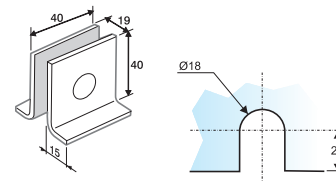
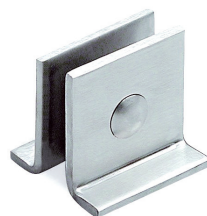

555N



FIJO UNA LUNA TALÓN 40 x 40 mm (CE)

Acabados:

Inox brillo	4176 IB
Inox mate	4176 IM

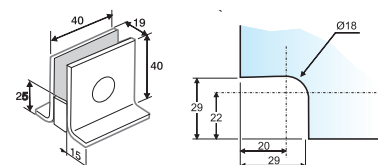
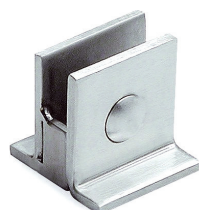

555V





Vidrio 10 mm

FIJO UNA LUNA TALADROS

40 x 40 mm (CE)

Acabados:

Inox brillo	4177 IB
Inox mate	4177 IM

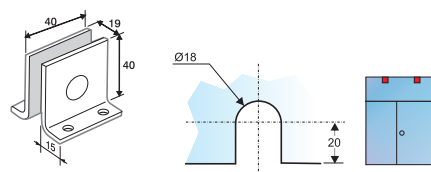
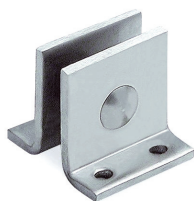

555NE

UNIÓN DOS LUNAS VERTICAL

80 x 40 mm (CE)

Acabados:

Inox brillo	4178 IB
Inox mate	4178 IM

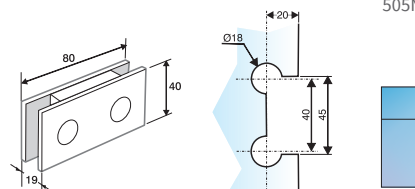
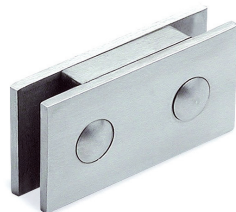

505N

UNIÓN DOS LUNAS

80 x 40 mm (CE)

Acabados:

Inox brillo	4179 IB
Inox mate	4179 IM

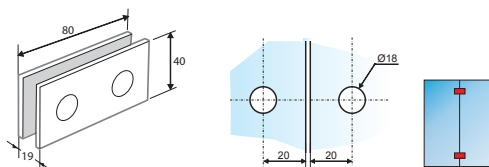

571N

UNIÓN CONTRAFUERTE

40 x 37 mm (CE)

Acabados:

Inox brillo	4183 IB
Inox mate	4183 IM

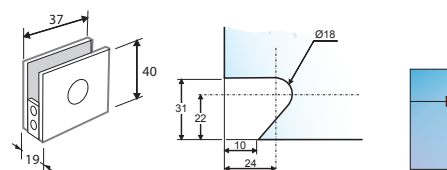
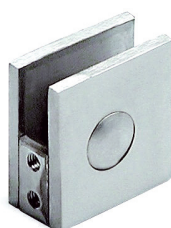

753N

UNIÓN TRES LUNAS

80 x 80 mm (CE)

Acabados:

Inox brillo	4184 IB
Inox mate	4184 IM

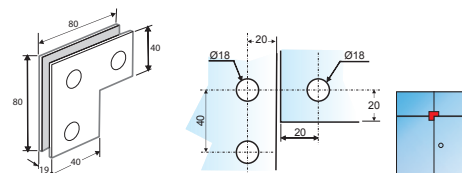

521N

90°

Acabados:

Inox brillo	4184.1 IB
Inox mate	4184.1 IM

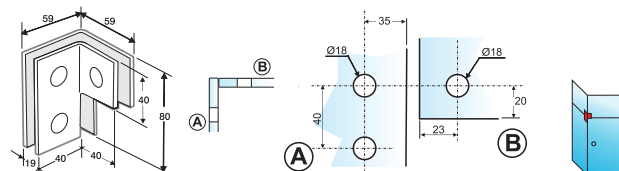

521N 90°

521 NVG

VARIACIÓN GRADOS

Acabados:

Inox brillo	4184.2 IB
Inox mate	4184.2 IM



*Indícanos la mano

* Bajo pedido

TALADROS CIEGOS

Acabados:

Inox brillo	4184.3 IB
Inox mate	4184.3 IM

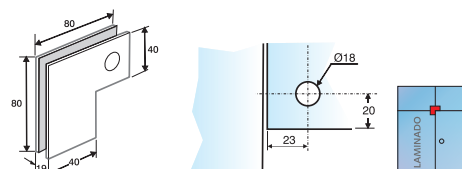

521NC

UNIÓN TRES LUNAS TOPE
80 x 80 mm (CE)

Acabados:

Inox brillo	4185 IB
Inox mate	4185 IM

*Indícanos la mano

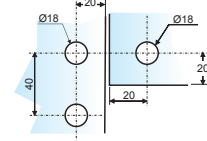
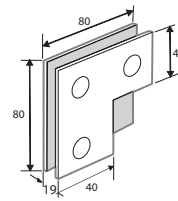

519N

90°

Acabados:

Inox brillo	4185.1 IB
Inox mate	4185.1 IM

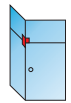
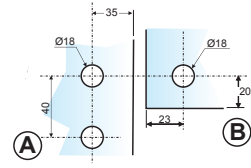
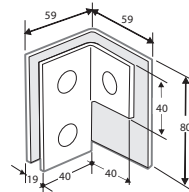

519N 90°
519NVG

VARIACIÓN GRADOS

Acabados:

Inox brillo	4185.2 IB
Inox mate	4185.2 IM

*Indícanos la mano

* Bajo pedido

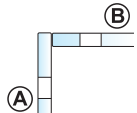

TALADROS CIEGOS (CE)

Acabados:

Inox brillo	4185.3 IB
Inox mate	4185.3 IM

*Indícanos la mano

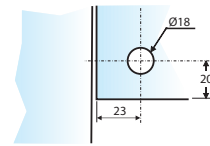
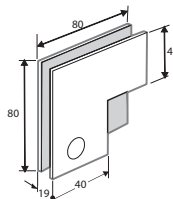

519NC

UNIÓN CUATRO LUNAS
80 x 80 mm (CE)

Acabados:

Inox brillo	4186 IB
Inox mate	4186 IM

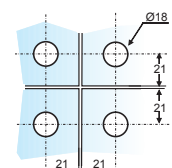
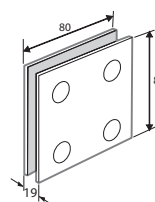

514N

90°

Acabados:

Inox brillo	4186.1 IB
Inox mate	4186.1 IM

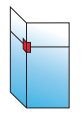
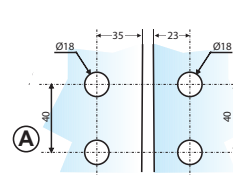
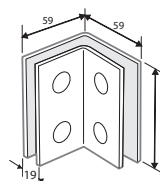
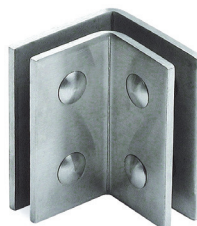

514N 90°
514NVG

VARIACIÓN GRADOS

Acabados:

Inox brillo	4186.2 IB
Inox mate	4186.2 IM

* Bajo pedido

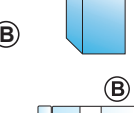
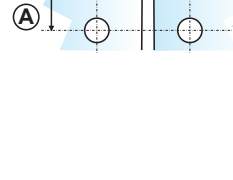
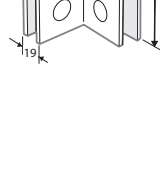



Vidrio 10 mm

UNIÓN LUNA TECHILLO

Acabados:

Inox brillo	4070 IB
Inox mate	4070 IM

SLT

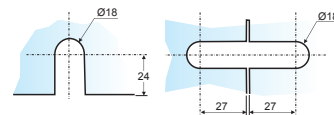
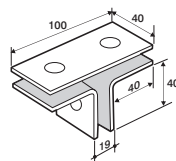
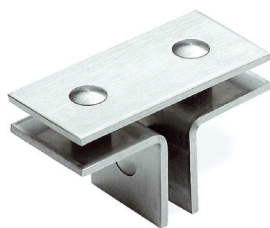

UNIÓN UNA LUNA TECHILLO

Acabados:

Inox brillo	4071 IB
Inox mate	4071 IM

S1LT

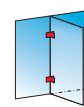
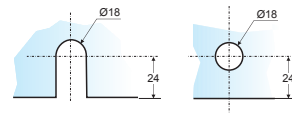
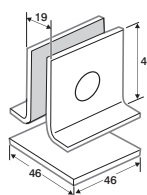
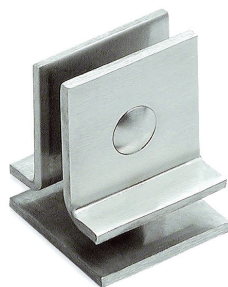

COMPLEMENTOS SERIE CE

CONJUNTO TORNILLO M-7 INTERIOR

Acabados:

Inox brillo	14040 IB
Inox mate	14040 IM

809



CONJUNTO TORNILLO M-11 IZQUIERDA

Acabados:

Inox brillo	14041 IB
Inox mate	14041 IM

810



GUIA BAJA PUERTA CORREDERA 50x30 mm

Acabados:

Inox brillo	4051 IB
-------------	---------

GBPC

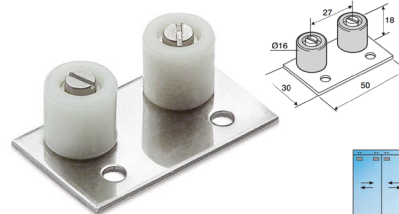

SERIE MILLENNIUM

Vidrio 10 mm

AISI-316

PERNIO ALTO REGULABLE

160 x 45 mm

Acabados:

Inox brillo	4140.TR IB
Inox mate	4140.TR IM

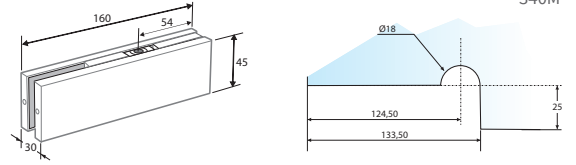

323M
340M

DESPLAZADO

Acabados:

Inox brillo	4150.TR IB
Inox mate	4150.TR IM

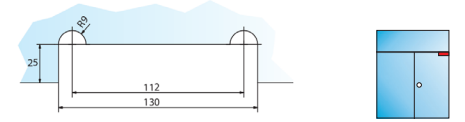

PERNIO BAJO REGULABLE REGLETA (CE)

160 x 45 mm

Medida máxima puerta: 2500 x 1100 mm

Peso máximo puerta: 70 kg

Acabados:

Inox brillo	4141.TR IB
Inox mate	4141.TR IM

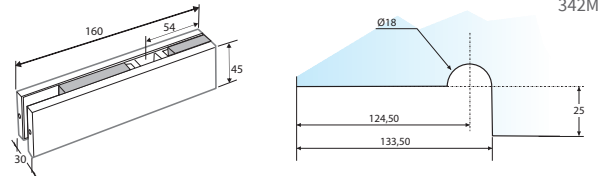

325M
342M

*Muesca desplazada de la serie milenium:

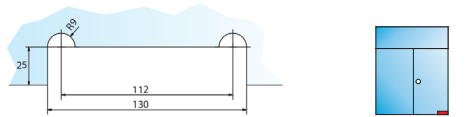

DESPLAZADO

Acabados:

Inox brillo	4151.TR IB
Inox mate	4151.TR IM

PERNIO BAJO REGULABLE CUADRADILLO FRANCÉS

160 x 45 mm

Acabados:

Inox brillo	4141.1TR IB
Inox mate	4141.1TR IM

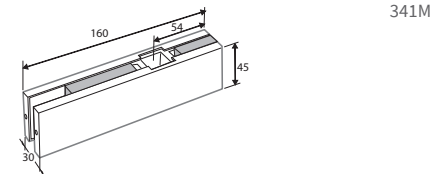

324M
341M

DESPLAZADO

Acabados:

Inox brillo	4151.1TR IB
Inox mate	4151.1TR IM

PERNIO BAJO REGULABLE EJE ALEMÁN

160 x 45 mm

Acabados:

Inox brillo	4141.2TR IB
Inox mate	4141.2TR IM

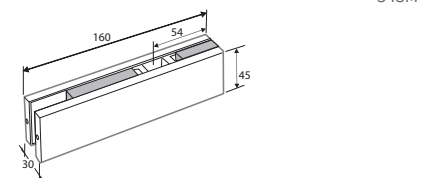

326M
343M

DESPLAZADO

Acabados:

Inox brillo	4151.2TR IB
Inox mate	4151.2TR IM

PUNTO DE GIRO SUPERIOR

114 x 25 mm

Para ref. 4140.TR

Acabados:

Inox brillo	4168.TR IB
Inox mate	4168.TR IM

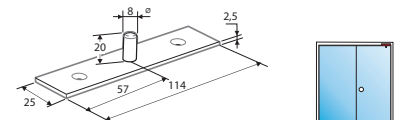
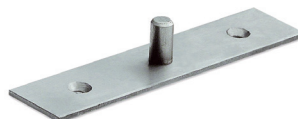

329M



Vidrio 10 mm AISI-316

PERNIO ALTO
160 x 45 mm

Acabados:

Inox brillo	4140.T IB
Inox mate	4140.T IM

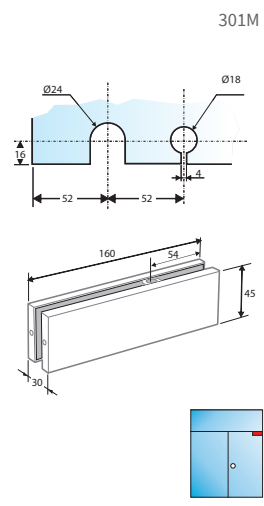

PERNIO BAJO REGLETA
160 x 45 mm (CE)

Medida máxima puerta: 2500 x 1100 mm

Peso máximo puerta: 70 kg

Acabados:

Inox brillo	4141.T IB
Inox mate	4141.T IM

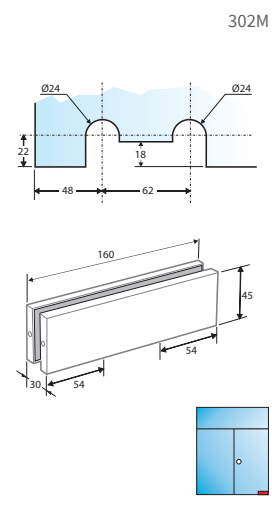

PUNTO DE GIRO SUPERIOR
114 x 25 mm

Para Ref. 4140.T

Acabados:

Inox brillo	4168.T IB
Inox mate	4168.T IM

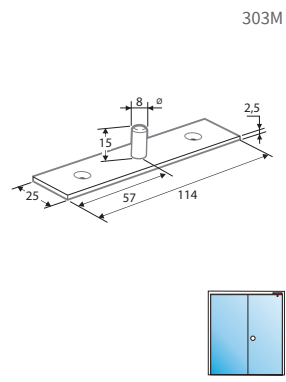
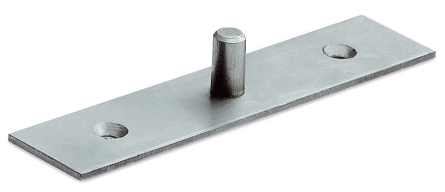

PUNTO DE GIRO MONTANTE
165 x 45 mm

Acabados:

Inox brillo	4160.T IB
Inox mate	4160.T IM

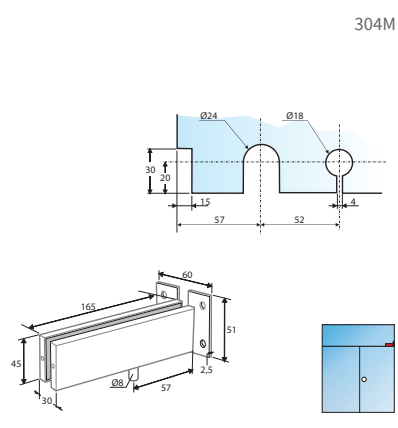

PUNTO DE GIRO MONTANTE DESPLAZADO

160 x 45 mm

Acabados:

Inox brillo	4162.T IB
Inox mate	4162.T IM

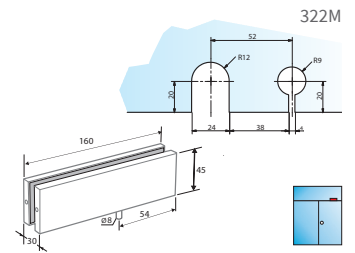

PUNTO DE GIRO MONTANTE DOBLE EN BATERÍA DE PUERTAS

320 x 45 mm

Acabados:

Inox brillo	4164.T IB
Inox mate	4164.T IM

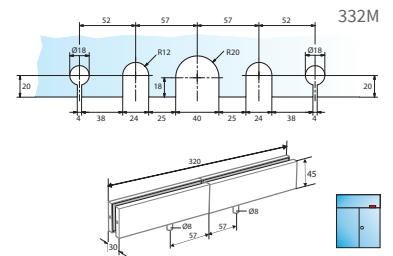

PUNTO DE GIRO LATERAL MONTANTE

210 x 95 mm

Acabados:

Inox brillo	4165.T IB
Inox mate	4165.T IM

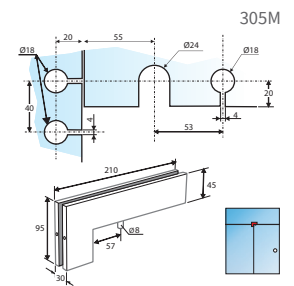

PUNTO DE GIRO LATERAL MONTANTE 90°

178 x 95 mm

Acabados:

Inox brillo	4165.1T IB
Inox mate	4165.1T IM

*Indícanos la mano

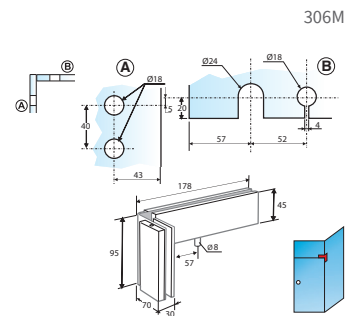

PUNTO DE GIRO LATERAL MONTANTE CON CONTRAFUERTE

210 x 95 mm

Acabados:

Inox brillo	4163.T IB
Inox mate	4163.T IM

*Indícanos la mano

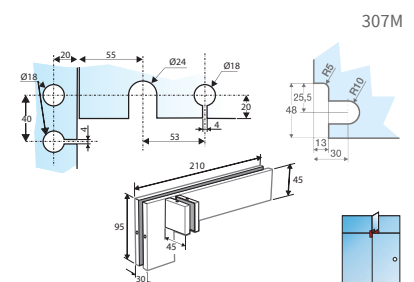

FIJO UNA LUNA

45 x 45 mm

Acabados:

Inox brillo	4175.T IB
Inox mate	4175.T IM

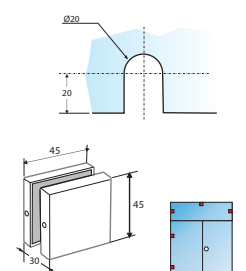



Vidrio 10 mm

AISI-316

UNIÓN DOS LUNAS

95 x 45 mm

Acabados:

Inox brillo	4179.T IB
Inox mate	4179.T IM

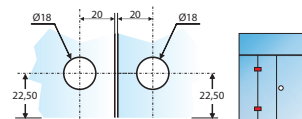
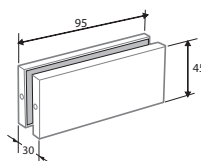

309M

UNIÓN DOS LUNAS VERTICAL

95 x 45 mm

Acabados:

Inox brillo	4178.T IB
Inox mate	4178.T IM

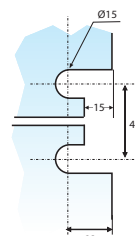
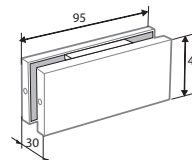

327M

UNIÓN DOS LUNAS TOPE

95 x 45 mm

Acabados:

Inox brillo	4080.T IB
Inox mate	4080.T IM

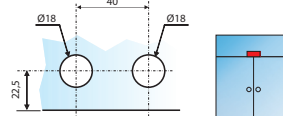
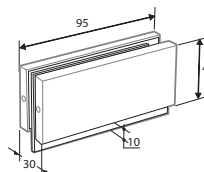

310M

UNIÓN DOS LUNAS 90°

70 x 45 mm

Acabados:

Inox brillo	4180.T IB
Inox mate	4180.T IM

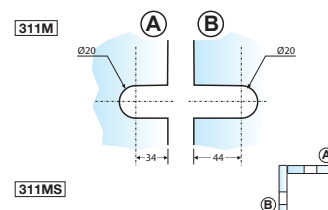
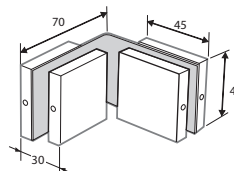

311M
311MS

UNIÓN DOS LUNAS 90°

SUELO/TECHO

Acabados:

Inox brillo	4180.1T IB
Inox mate	4180.1T IM

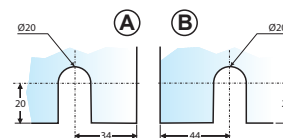

UNIÓN DOS LUNAS CON CONTRAFUERTE

95 x 45 mm

Acabados:

Inox brillo	4181.T IB
Inox mate	4181.T IM

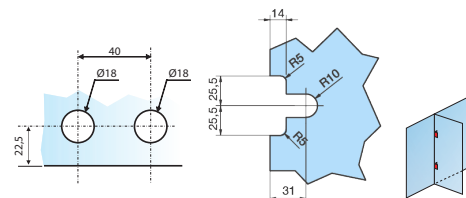
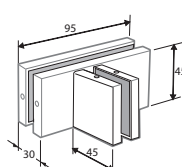
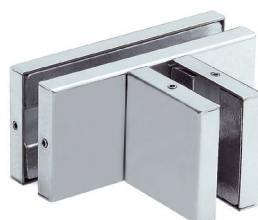

312M

UNIÓN TRES LUNAS

95 x 95 mm

Acabados:

Inox brillo	4184.T IB
Inox mate	4184.T IM

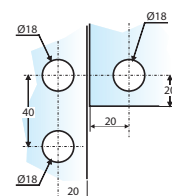
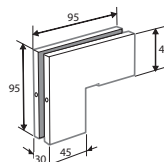

314M

UNIÓN TRES LUNAS 90°

Acabados:

Inox brillo	4184.1T IB
Inox mate	4184.1T IM

*Indícanos la mano

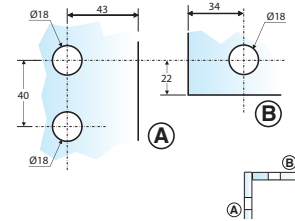
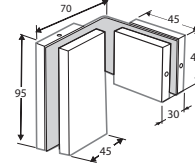

315M

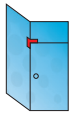

UNIÓN TRES LUNAS CON CONTRAFUERTE

Acabados:

Inox brillo	4184.4T IB
Inox mate	4184.4T IM

*Indícanos la mano

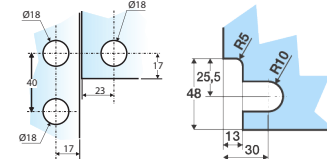
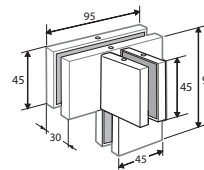

316M



UNIÓN TRES LUNAS TOPE 95 x 95 mm

Acabados:

Inox brillo	4185.T IB
Inox mate	4185.T IM

*Indícanos la mano

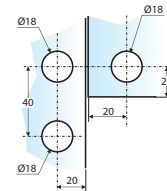
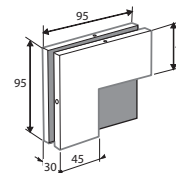

317M



UNIÓN TRES LUNAS TOPE 90°

Acabados:

Inox brillo	4185.1T IB
Inox mate	4185.1T IM

*Indícanos la mano

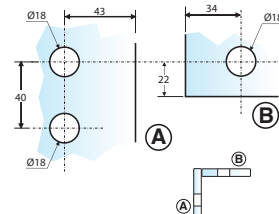
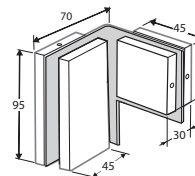

318M

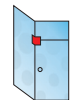

UNIÓN TRES LUNAS TOPE CON CONTRAFUERTE

Acabados:

Inox brillo	4185.4T IB
Inox mate	4185.4T IM

*Indícanos la mano

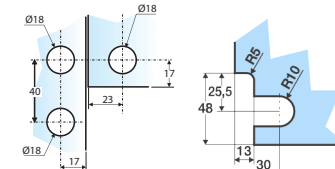
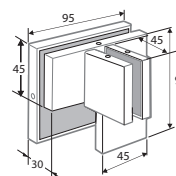

319M



UNIÓN CUATRO LUNAS 90°

Acabados:

Inox brillo	4186.1T IB
Inox mate	4186.1T IM

*Indícanos la mano

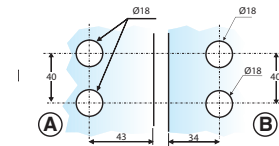
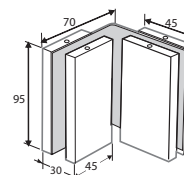

321M

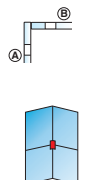



Vidrio 10 mm

AISI-316

UNIÓN CUATRO LUNAS

95 x 95 mm

Acabados:

Inox brillo	4186.T IB
Inox mate	4186.T IM

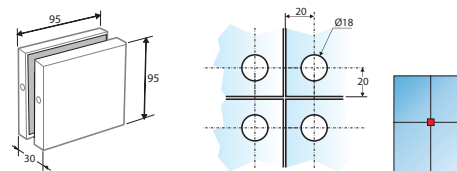

320M

PERNIO ALTO GIRO DESPLAZADO

160 x 45 mm

Acabados:

Inox brillo	4143.T IB
Inox mate	4143.T IM

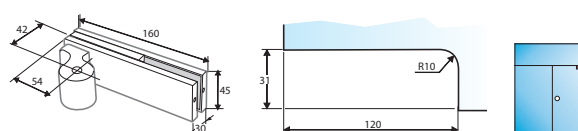

334M

*Indícanos la mano

PERNIO BAJO CUADRADILLO FRANCÉS

GIRO DESPLAZADO

160 x 45 mm

Acabados:

Inox brillo	4144.T IB
Inox mate	4144.T IM

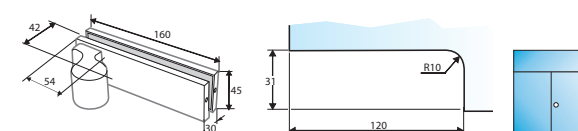

333M

*Indícanos la mano

PUNTO DE GIRO MONTANTE

GIRO DESPLAZADO

160 x 45 mm

Acabados:

Inox brillo	4167.T IB
Inox mate	4167.T IM

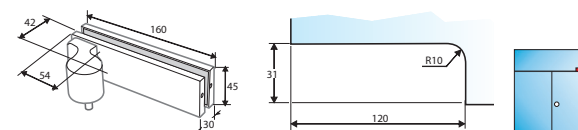

335M

*Indícanos la mano

PUNTO DE GIRO LATERAL MONTANTE

GIRO DESPLAZADO

210 x 95 mm

Acabados:

Inox brillo	4166.T IB
Inox mate	4166.T IM

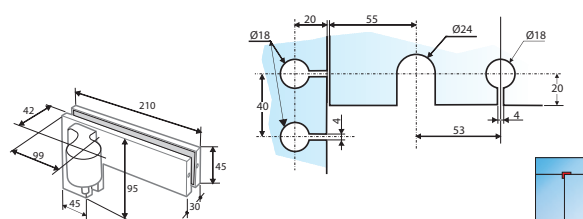

336M

*Indícanos la mano

SERIE T

TEJUELO REGLETA (CE)

463N

Acabados:

Inox brillo	4156 IB
Inox mate	4156 IM

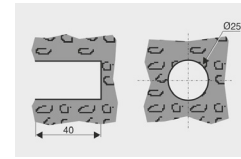
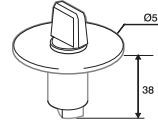

TEJUELO CUADRADILLO FRANCÉS (16/19)

463 C
463 CI

Acabados:

Inox brillo	4056 IB
Inox mate	4056 IM

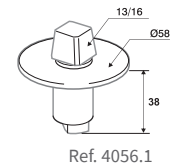
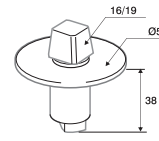
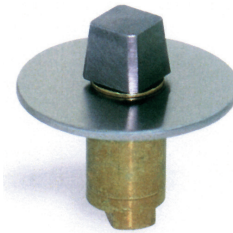

TEJUELO CUADRADILLO ITALIANO (13/16)

Acabados:

Inox brillo	4056.1 IB
Inox mate	4056.1 IM

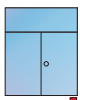
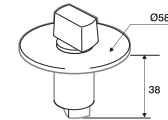
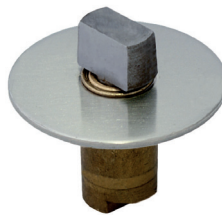

TEJUELO ALEMÁN

463E

Acabados:

Inox brillo	4054 IB
Inox mate	4054 IM

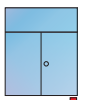
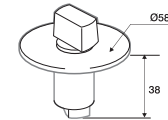
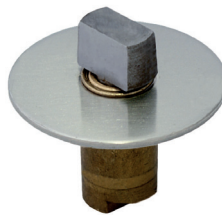

¿CÓMO CALCULAR EL PESO DEL VIDRIO?

Área (alto x ancho) x espesor en (mm) x 2.5 (densidad del cristal).

Hay que multiplicar los metros cuadrados (alto x ancho) del vidrio, por el espesor en milímetros, el resultado hay que multiplicarlo por el factor (2.5)



SERIE GT AISI-316

GRANDES VENTAJAS EN SU NÚCLEO EXTRAÍBLE

- Debido a su núcleo extraíble en el pernio alto, puede colocar los pernios en su taller, sin necesidad de realizar el montaje en la misma obra.
- Olvídense de usar pegamentos, ya que es un pernio-presión con juntas especiales de gran adherencia.
- Ensayos efectuados por nuestros técnicos en puertas de grandes dimensiones nos dan la razón.
- Gran movilidad en su núcleo extraíble, pues con una holgura de hasta 10 mm permite su colocación sin mover los pernios (ideal para paredes con desnivel).

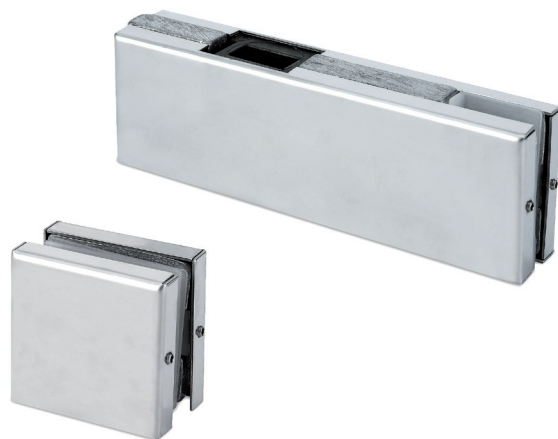

* Bajo pedido para vidrio de 12 hasta 22 mm
* Para otros acabados, consúltanos

PERNIO ALTO 160 x 50 mm

Medida máxima de la puerta: 2500 x 1100 mm
Peso máximo de la puerta: 75 kg

Acabados:

Vidrio 10 mm	Inox brillo Inox mate	5840 IB 5840 IM
Vidrio 12 mm	Inox brillo Inox mate	5840.12 IB 5840.12 IM

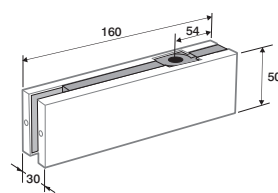
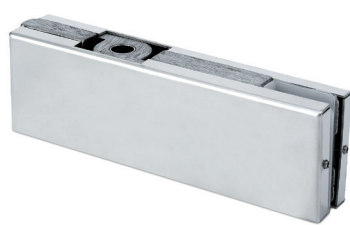

GT901
GT901V12
GT901D
GT901DV12

DESPLAZADO

Acabados:

Vidrio 10 mm	Inox brillo Inox mate	5844 IB 5844 IM
Vidrio 12 mm	Inox brillo Inox mate	5844.12 IB 5844.12 IM

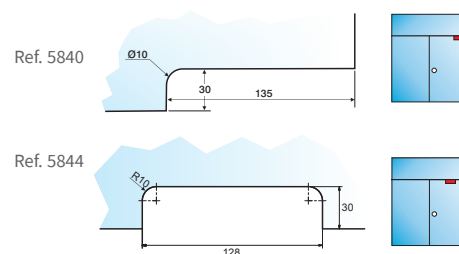

PERNIO BAJO REGLETA 160 x 50 mm

Medida máxima de la puerta: 2500 x 1100 mm
Peso máximo de la puerta: 75 kg

Acabados:

Vidrio 10 mm	Inox brillo Inox mate	5841 IB 5841 IM
Vidrio 12 mm	Inox brillo Inox mate	5841.12 IB 5841.12 IM

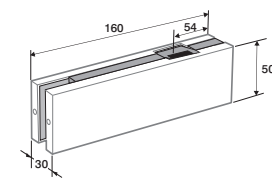

GT902R
GT902RV12
GT902RD
GT902RDV12

DESPLAZADO

Acabados:

Vidrio 10 mm	Inox brillo Inox mate	5845 IB 5845 IM
Vidrio 12 mm	Inox brillo Inox mate	5845.12 IB 5845.12 IM

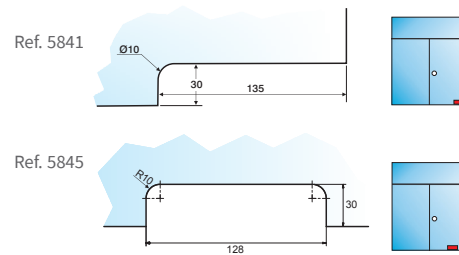

PERNIO BAJO CUADRADILLO FRANCÉS

160 x 50 mm

Medida máxima de la puerta: 2500 x 1100 mm

Peso máximo de la puerta: 75 kg

Acabados:

Vidrio 10 mm	Inox brillo Inox mate	5842 IB 5842 IM
Vidrio 12 mm	Inox brillo Inox mate	5842.12 IB 5842.12 IM

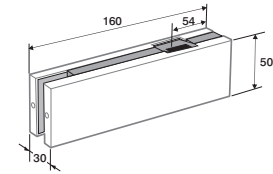

GT902C
GT902CV12
GT902CD
GT902CDV12

DESPLAZADO

Acabados:

Vidrio 10 mm	Inox brillo Inox mate	5846 IB 5846 IM
Vidrio 12 mm	Inox brillo Inox mate	5846.12 IB 5846.12 IM

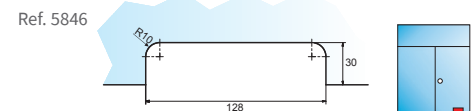
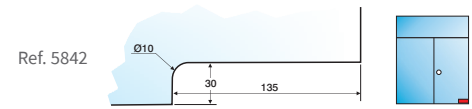

PERNIO BAJO EUROPEO

160 x 50 mm

Medida máxima de la puerta: 2500 x 1100 mm

Peso máximo de la puerta: 75 kg

Acabados:

Vidrio 10 mm	Inox brillo Inox mate	5843 IB 5843 IM
Vidrio 12 mm	Inox brillo Inox mate	5843.12 IB 5843.12 IM

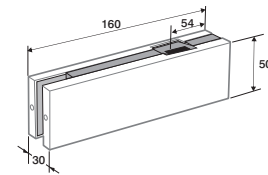

GT902E
GT902EV12
GT902ED
GT902EDV12

DESPLAZADO

Acabados:

Vidrio 10 mm	Inox brillo Inox mate	5847 IB 5847 IM
Vidrio 12 mm	Inox brillo Inox mate	5847.12 IB 5847.12 IM

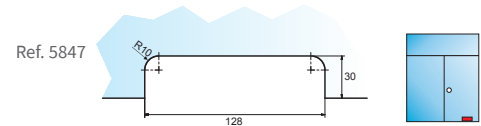
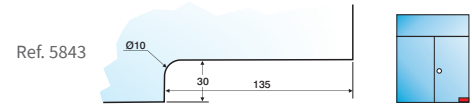

NÚCLEO EXTRAÍBLE PERNIO ALTO

M37

5895

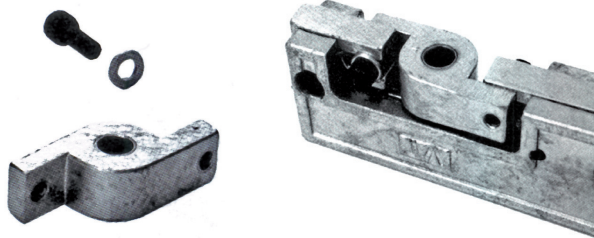

NÚCLEO EXTRAÍBLE PERNIO BAJO REGLETA

M38

5896

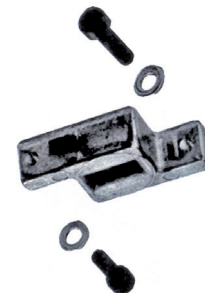

NÚCLEO EXTRAÍBLE PERNIO BAJO CUADRADILLO FRANCÉS

M39

5897

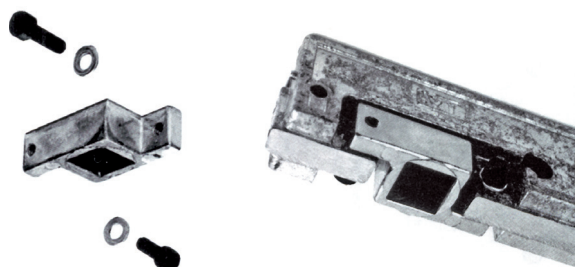

NÚCLEO EXTRAÍBLE PERNIO BAJO EUROPEO

P14/1

5898





AISI-316

PUNTO DE GIRO

114 x 25 mm

Acabados:

Inox brillo	5868 IB
Inox mate	5868 IM

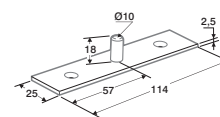

GT900

PUNTO DE GIRO MONTANTE

165 x 50 mm

Acabados:

Vidrio 10 mm	Inox brillo	5860 IB
	Inox mate	5860 IM
Vidrio 12 mm	Inox brillo	5860.12 IB
	Inox mate	5860.12 IM

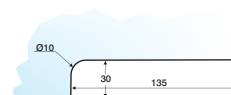
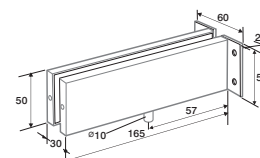

GT903
GT903V12

PUNTO DE GIRO MONTANTE DESPLAZADO

160 x 50 mm

Acabados:

Vidrio 10 mm	Inox brillo	5862 IB
	Inox mate	5862 IM
Vidrio 12 mm	Inox brillo	5862.12 IB
	Inox mate	5862.12 IM

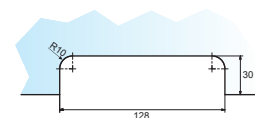
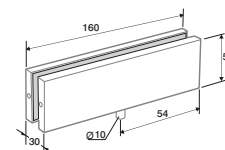

GT903D
GT903DV12

PUNTO DE GIRO LATERAL MONTANTE

212 x 105 mm

Acabados:

Vidrio 10 mm	Inox brillo	5865 IB
	Inox mate	5865 IM
Vidrio 12 mm	Inox brillo	5865.12 IB
	Inox mate	5865.12 IM

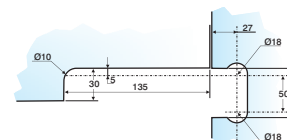
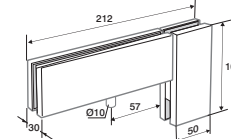

GT904
GT904V12

PUNTO DE GIRO LATERAL MONTANTE

ÁNGULO 90°

178 x 105 mm

Acabados:

Inox brillo	5866 IB
Inox mate	5866 IM

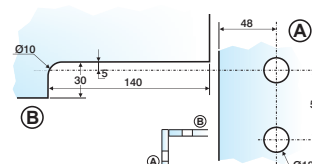
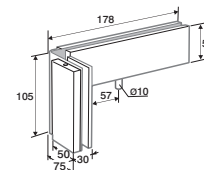

GT922

*Indícanos la mano

PUNTO DE GIRO TECHILLO

PARA Ref. 5840

Acabados:

Inox brillo	5869 IB
Inox mate	5869 IM

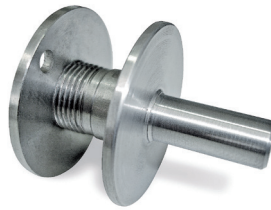

GT923

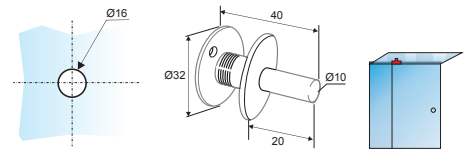

PUNTO DE GIRO LATERAL MONTANTE CON CONTRAFUERTE 212 x 105 mm

Acabados:

Inox brillo	5863 IB
Inox mate	5863 IM



GT905

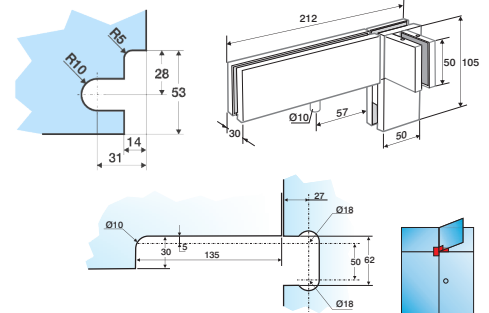

* Indicar mano

PUNTO DE GIRO MONTANTE DOBLE BATERÍA PUERTAS 320 x 50 mm

Acabados:

Inox brillo	5864 IB
Inox mate	5864 IM



GT926

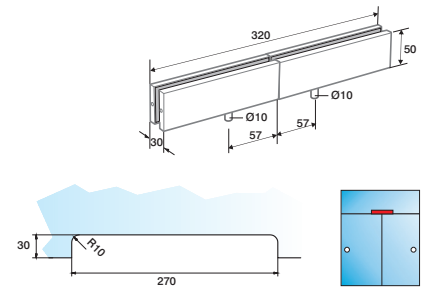

UNIÓN UNA LUNA 50 x 50 mm

Acabados:

Vidrio 10 mm	Inox brillo	5875 IB
	Inox mate	5875 IM
Vidrio 12 mm	Inox brillo	5875.12 IB
	Inox mate	5875.12 IM



GT906
GT906V12

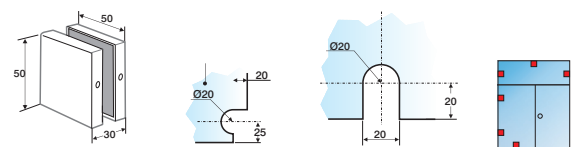

UNIÓN UNA LUNA VÉRTICES 50 x 50 mm

Acabados:

Inox brillo	5876 IB
Inox mate	5876 IM



GT907

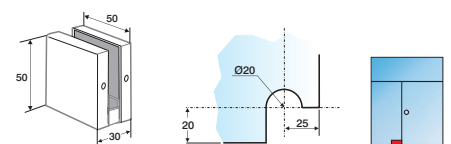

UNIÓN DOS LUNAS 105 x 50 mm

Acabados:

Inox brillo	5879 IB
Inox mate	5879 IM



GT908

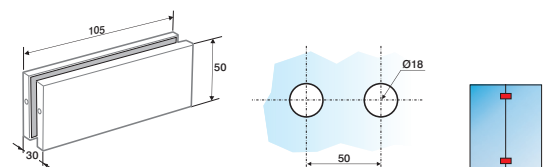



AISI-316

UNIÓN TRES LUNAS

105 x 105 mm

Acabados:

Vidrio 10 mm	Inox brillo	5884 IB
	Inox mate	5884 IM
Vidrio 12 mm	Inox brillo	5884.12 IB
	Inox mate	5884.12 IM

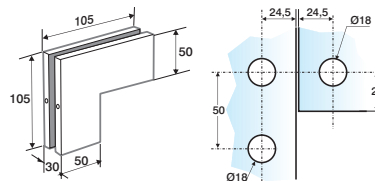

GT910
GT910V12



UNIÓN TRES LUNAS TOPE

105 x 105 mm

Acabados:

Inox brillo	5885 IB
Inox mate	5885 IM

*Indícanos la mano

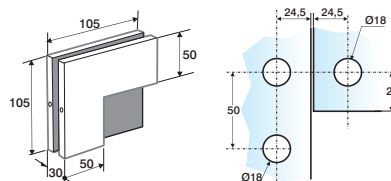

GT911



UNIÓN CUATRO LUNAS

105 x 105 mm

Acabados:

Inox brillo	5886 IB
Inox mate	5886 IM

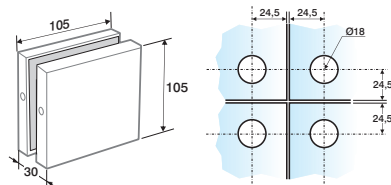

GT912



UNIÓN DOS LUNAS TOPE

105 x 50 mm

Acabados:

Inox brillo	5880 IB
Inox mate	5880 IM

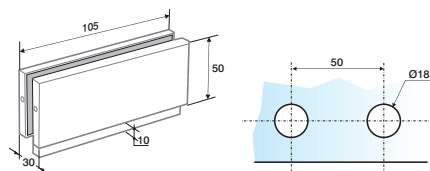

GT913



UNIÓN TRES LUNAS CON CONTRAFUERTE

105 x 50 mm

Acabados:

Inox brillo	5883 IB
Inox mate	5883 IM

*Indícanos la mano

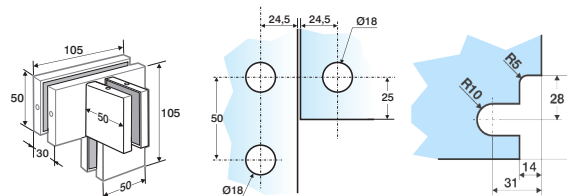

GT914

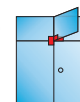

UNIÓN TRES LUNAS TOPE CON CONTRAFUERTE

105 x 105 mm

Acabados:

Inox brillo	5887 IB
Inox mate	5887 IM

*Indícanos la mano

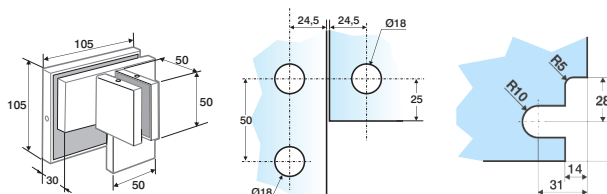

GT915

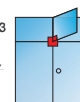

**UNIÓN DOS LUNAS
CON CONTRAFUERTE
105 x 50 mm**

GT916

Acabados:

Inox brillo	5881 IB
Inox mate	5881 IM

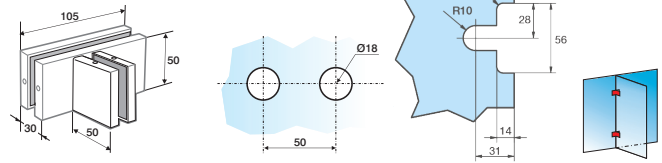

**UNIÓN DOS LUNAS
ÁNGULO 90°**

GT917

Acabados:

Inox brillo	5890 IB
Inox mate	5890 IM

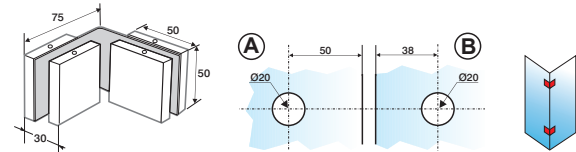

**UNIÓN DOS LUNAS
ÁNGULO 90° SUELO/TECHO**

GT918

Acabados:

Inox brillo	5891 IB
Inox mate	5891 IM

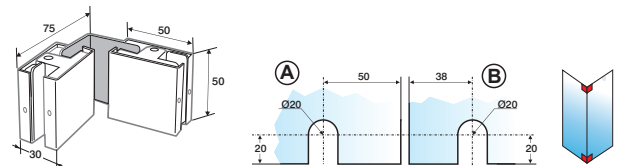

**UNIÓN TRES LUNAS
ÁNGULO 90°**

GT919

Acabados:

Inox brillo	5882 IB
Inox mate	5882 IM

*Indícanos la mano

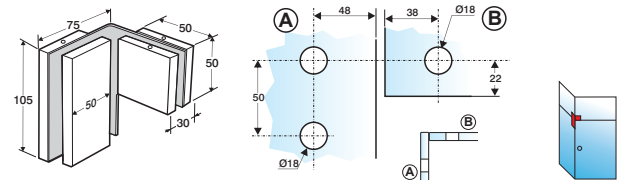

**UNIÓN TRES LUNAS TOPE
ÁNGULO 90°**

GT920

Acabados:

Inox brillo	5888 IB
Inox mate	5888 IM

*Indícanos la mano

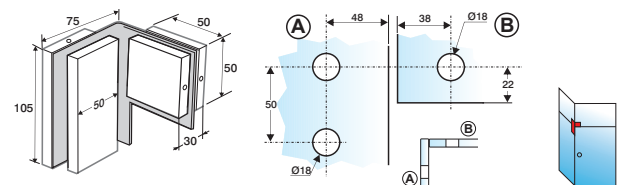

**UNIÓN CUATRO LUNAS
ÁNGULO 90°**

GT921

Acabados:

Inox brillo	5889 IB
Inox mate	5889 IM

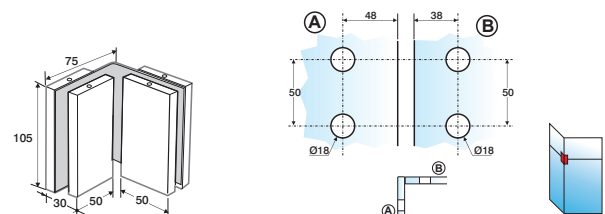



AISI-316

UNIÓN DOS LUNAS VERTICAL

105 x 50 mm

Acabados:

Inox brillo	5878 IB
Inox mate	5878 IM

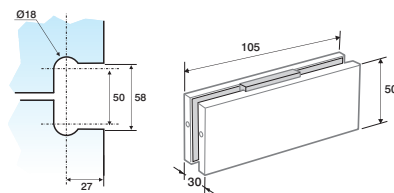

GT924



UNIÓN DOS LUNAS SIN ANCLAJE INTERIOR

50 x 50 mm

Acabados:

Inox brillo	5872 IB
Inox mate	5872 IM

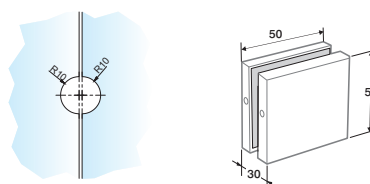

GT925



SERIE 9000 FLAT

AISI-316

GRANDES DIMENSIONES

NOVEDAD

9000 FLAT

Características técnicas:

- Herrajes sin tornillería al exterior de la instalación, ofreciendo mayor elegancia a la misma. La tornillería de apriete queda en el interior de la instalación, ocultando su visibilidad.
- Placas de apriete al vidrio fabricadas con chapa de acero inoxidable AISI 304 de 8 mm de espesor.
- Tornillería allen fabricada en acero inoxidable A2.
- Núcleos internos en micro fusión de acero inoxidable AISI 303.
- Pernio alto con núcleo de giro a rodamiento de agujas.
- Ejes de giro de Ø10 mm.
- Núcleo leva para los modelos de cierrapuertas R regleta y C cuadradillo 16/19 en AISI 304.

Acabados:

Inox brillo
Inox mate

* Para otros acabados, consulta la carta de acabados
 * Colores RAL consulta ref. color

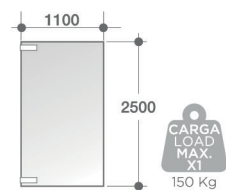
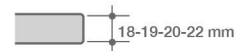
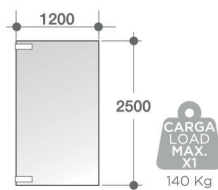
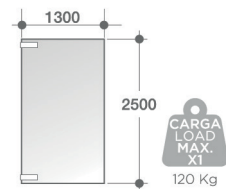
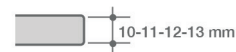

PERNIO ALTO **NOVEDAD**

Especificar el espesor del vidrio y el giro deseado (54mm - 106mm - 158mm)

Acabados:

Vidrio 10-12	Inox brillo	4140.1F IB
	Inox mate	4140.1F IM
Vidrio 13-15	Inox brillo	4140.2F IB
	Inox mate	4140.2F IM

*Bajo pedido hasta 22mm.

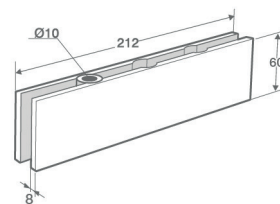

9001 FLAT

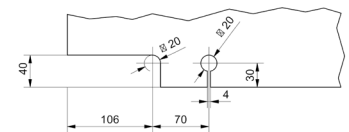

Giro 54 mm

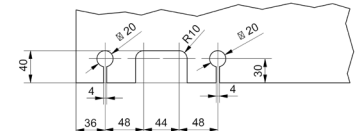

Giro 106 mm

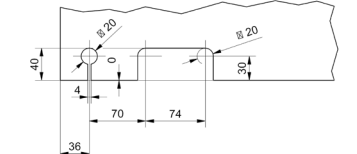

Giro 158 mm

PERNIO BAJO REGLETA **NOVEDAD**

Especificar espesor del vidrio y el giro deseado (54mm - 106mm - 158mm)

Acabados:

Vidrio 10-11	Inox brillo	4142.1F IB
	Inox mate	4142.1F IM
Vidrio 12-13	Inox brillo	4142.2F IB
	Inox mate	4142.2F IM

*Bajo pedido hasta 22mm.

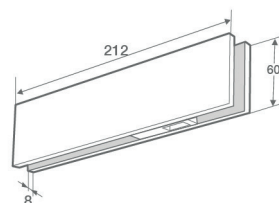
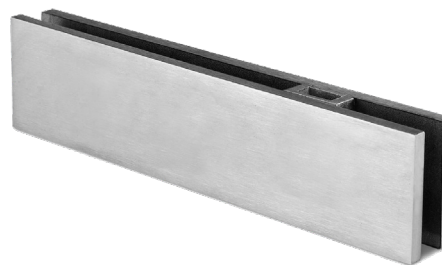

9002 FLAT

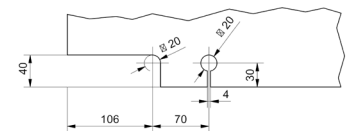

Giro 54 mm

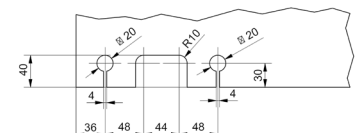

Giro 106 mm

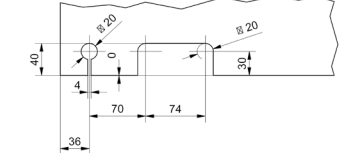

Giro 158 mm

PERNIO BAJO CUADRADILLO FRANCÉS **NOVEDAD**

Especificar espesor del vidrio y el giro deseado (54mm - 106mm - 158mm)

Acabados:

Vidrio 10-11	Inox brillo	4144.1F IB
	Inox mate	4144.1F IM
Vidrio 12-14	Inox brillo	4144.2F IB
	Inox mate	4144.2F IM

*Bajo pedido hasta 22mm.

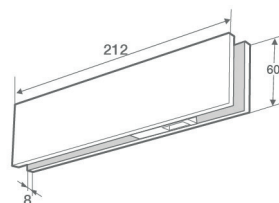

9006 FLAT

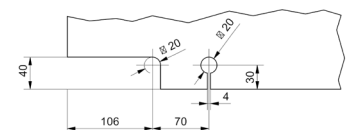

Giro 54 mm

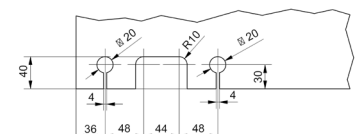

Giro 106 mm

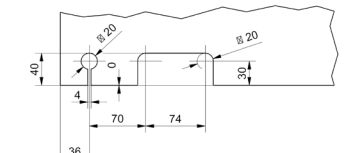

Giro 158 mm



AISI-316

PUNTO DE GIRO MONTANTE **NOVEDAD**

Acabados:

Vidrio 10-12	Inox brillo Inox mate	4160.1F IB 4160.1F IM
Vidrio 13-15	Inox brillo Inox mate	4160.2F IB 4160.2F IM

*Bajo pedido hasta 22mm.

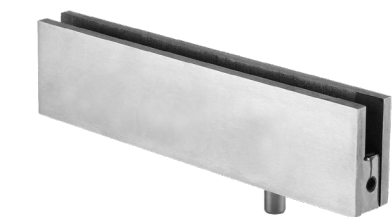

9003 FLAT

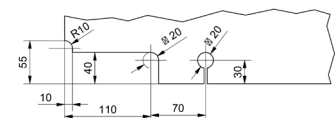

Giro 54 mm

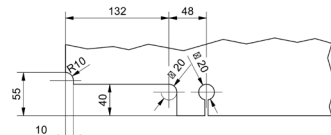

Giro 106 mm

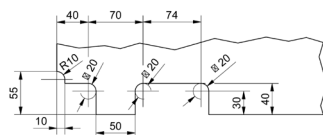

Giro 158 mm

Eje de giro con rotula, tolera desviaciones de 2° en todas direcciones.

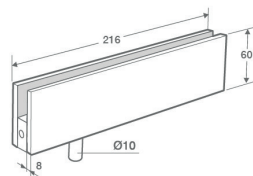

PUNTO DE GIRO LATERAL MONTANTE **NOVEDAD**

Acabados:

Vidrio 10-12	Inox brillo Inox mate	4165.1F IB 4165.1F IM
Vidrio 13-15	Inox brillo Inox mate	4165.2F IB 4165.2F IM

*Bajo pedido hasta 22mm.



9004 FLAT

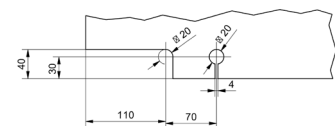

Giro 54 mm

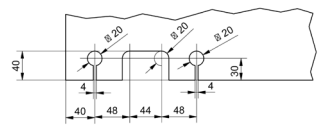

Giro 106 mm

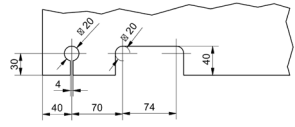

Giro 158 mm



Eje de giro con rotula, tolera desviaciones de 2° en todas direcciones.

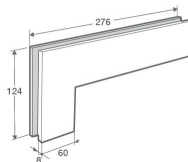

UNIÓN TRES LUNAS **NOVEDAD**

Acabados:

Vidrio 10-13	Inox brillo Inox mate	4184.1F IB 4184.1F IM
--------------	--------------------------	----------------------------------------

*Bajo pedido hasta 22mm.

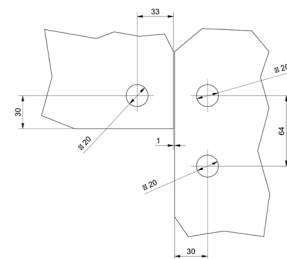
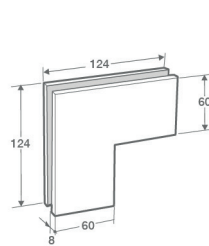

9005 FLAT



PUNTO DE GIRO SUPERIOR

Acabados:

Inox brillo	4168.1 IB
Inox mate	4168.1 IM

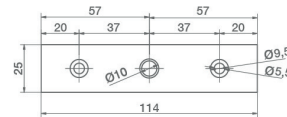
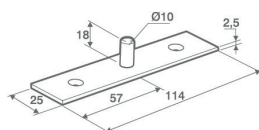

9000 FLAT



UNIÓN UNA LUNA ANCLAJE INTERIOR **NOVEDAD**

Acabados:

Vidrio 10-13	Inox brillo Inox mate	4172.1F IB 4172.1F IM
--------------	--------------------------	----------------------------------------

* Bajo pedido hasta 22mm.

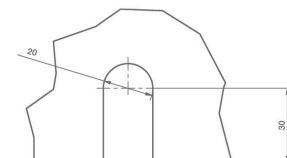
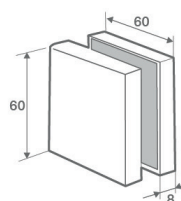
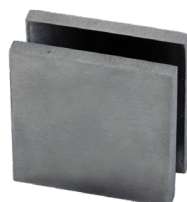

9007 FLAT

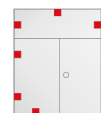

SERIE MAJESTIC

Vidrio 10-12 mm

PERNIO ALTO CON TAPAS PEQUEÑAS

Acabados:

Inox brillo	4033 IB
Inox mate	4033 IM

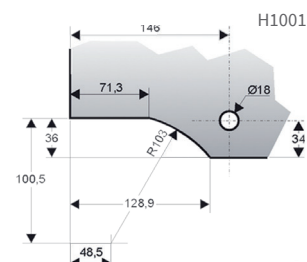
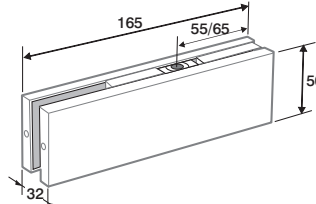

PERNIO BAJO REGULABLE
CUADRADILLO FRANCÉS 16/19

Acabados:

Inox brillo	4037 IB
Inox mate	4037 IM

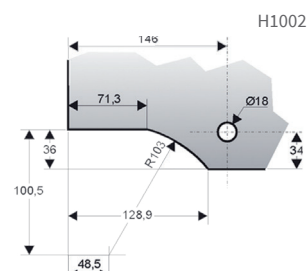
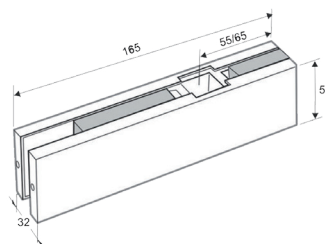

PUNTO DE GIRO MONTANTE

Acabados:

Inox brillo	4034 IB
Inox mate	4034 IM

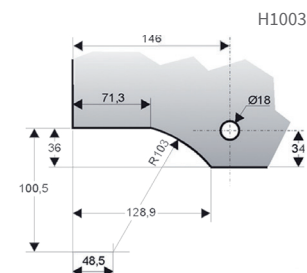
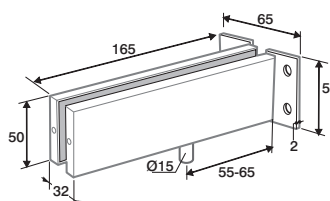

PUNTO DE GIRO LATERAL MONTANTE

Acabados:

Inox brillo	4035 IB
Inox mate	4035 IM

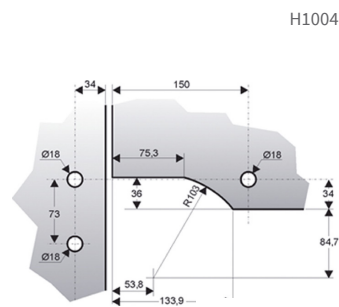
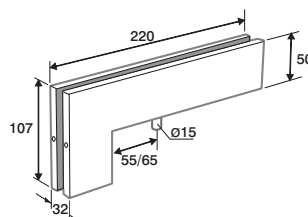

PUNTO GIRO SUPERIOR

Acabados:

Inox brillo	4033.1 IB
Inox mate	4033.1 IM

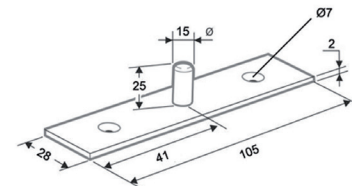

UNIÓN TRES LUNAS

Acabados:

Inox brillo	4036 IB
Inox mate	4036 IM

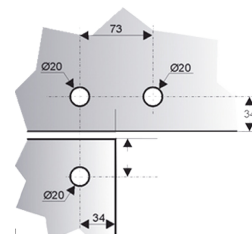
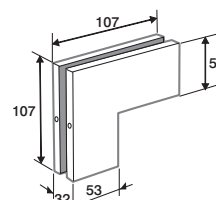



SERIE CON TAPAS-ÉLITE

Vidrio 8/10/12 mm

PERNIO ALTO

V 501

Acabados:

Plata brillo **3211 PB**

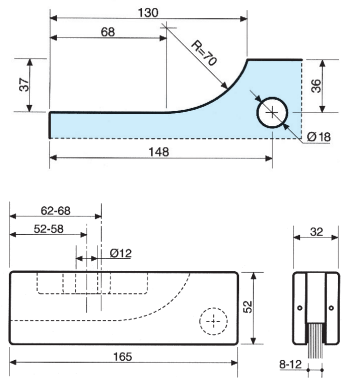
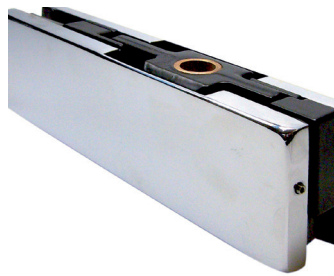

**PERNIO BAJO
CUADRADILLO ITALIANO 13/16**

V 500

Acabados:

Plata brillo **3210 PB**

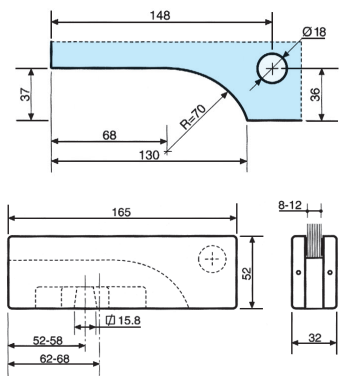
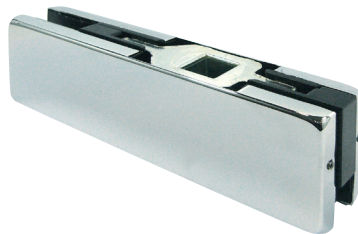

PUNTO DE GIRO SUPERIOR

V 502

Acabados:

Plata brillo **3212 PB**

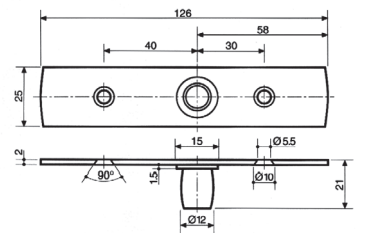

PUNTO DE GIRO MONTANTE

V 511

Acabados:

Plata brillo **3220 PB**

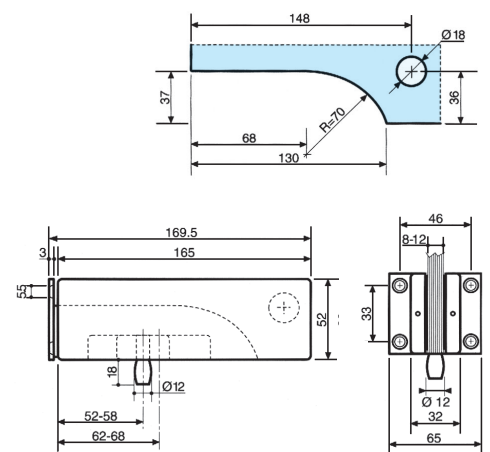

Vidrio 8/10/12 mm

PUNTO DE GIRO LATERAL MONTANTE

Acabados:

Plata brillo **3217 PB**



V 508

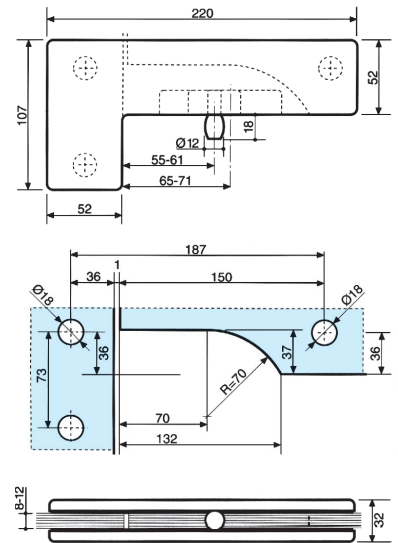

UNIÓN TRES LUNAS

Acabados:

Plata brillo **3218 PB**



V 509

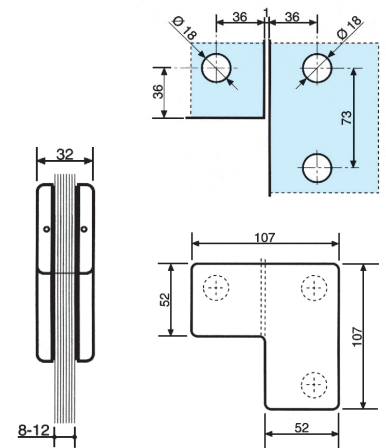

FIJO UNA LUNA

Acabados:

Plata brillo **3237 PB**

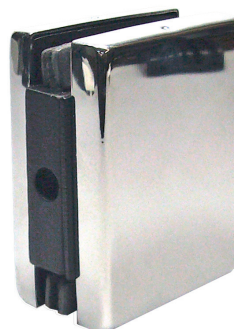

V 528

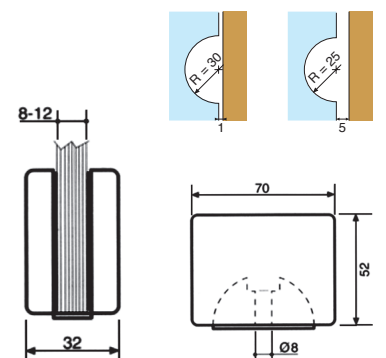



VENTANA HABLA-ESCUCHA

VENTANA HABLA-ESCUCHA

Acabados:

Plata brillo	10 mm	877 PB
	12 mm	877.1 PB
	18 mm	877.2 PB
	24 mm	877.3 PB



VA180
VA212
VA218
VA224
VA2540

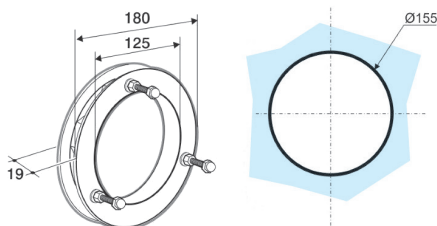

Ref. 877 - 10 mm

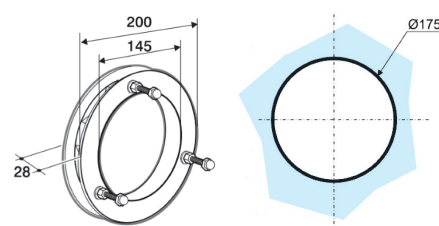

Ref. 877.2 - 18 mm

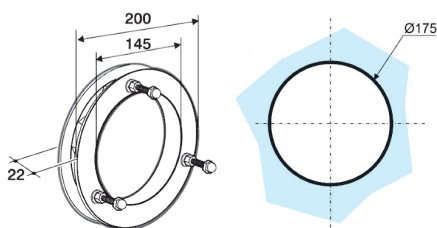

Ref. 877.1 - 12 mm

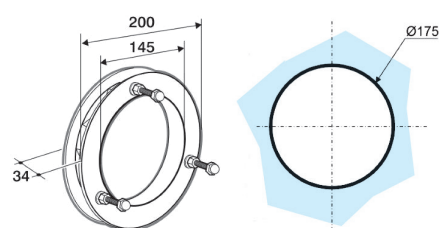

Ref. 877.3 - 24 mm

VENTANA HABLA-ESCUCHA REGULABLE

Acabados:

Plata brillo	25/40 mm	877.4 PB
--------------	----------	-----------------

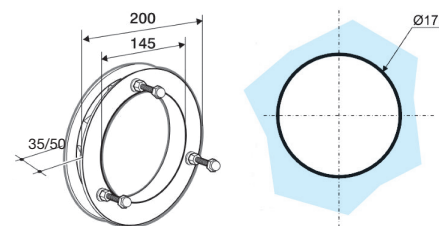

Ref. 877.4 - 25/40 mm

VIDRIO HABLA-ESCUCHA

Acabados:

10 mm	877.V
12 mm	877.1V
24 mm	877.3V
8+8+8 (BR2)	877.4V

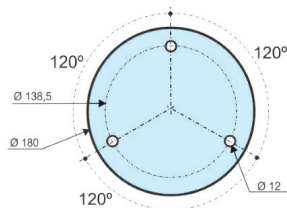

Ref. 877.V

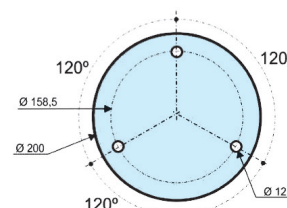

Ref. 877.1V / 877.3V

SERIE SV-SWING **PARA PUERTAS PRACTICABLES** Vidrio 10/12 mm

SV-SWING

SV-SWING es un sistema de divisiones y puertas de vidrio, de puerta batiente, tanto simple, de hasta 120 kg de peso y para vidrios de entre 10 y 12 mm. Sistema de herrajes de acero inoxidable con un acabado de gran calidad, de modo que pueden ser visibles y dar un toque de diseño a la instalación.

Diferentes herrajes regulables y articulados que se pueden combinar de múltiples formas.

Acabados:

- Inox mate

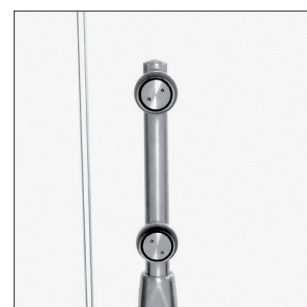
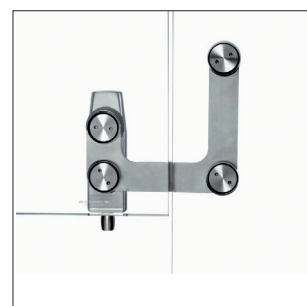
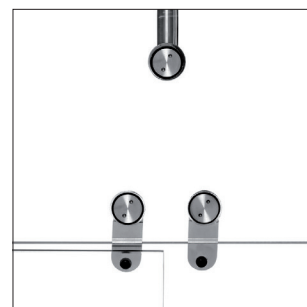
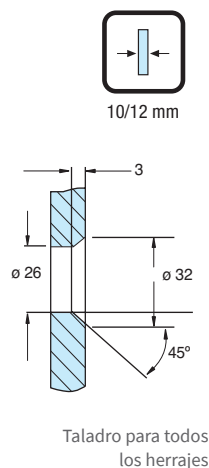
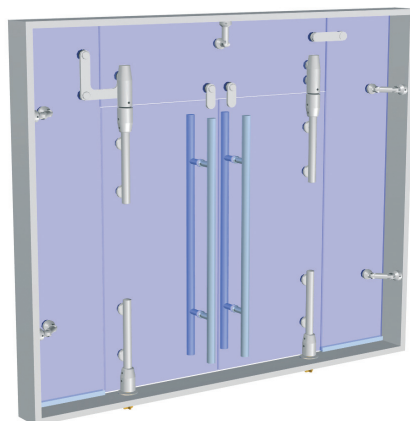

SOPORTE PARED-VIDRIO

1 ARTICULACIÓN

120/75

2992.1 IM

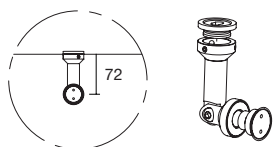

SOPORTE VIDRIO-VIDRIO

2 ARTICULACIONES

120/79

2992.3 IM

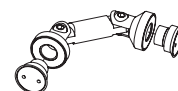

SOPORTE PARED-VIDRIO

2 ARTICULACIONES

120/77

2992.2 IM

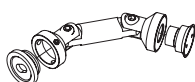

SOPORTE VIDRIO-VIDRIO

4 ARTICULACIONES

120/81

2992.4 IM

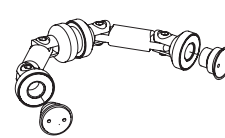

PIVOTE EXPANSIÓN TECHO

120/98

2990 IM**TEJUELO REGLETA ESPAÑOLA**

463N

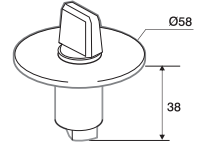
4156 IM**PUNTO DE GIRO MONTANTE**

120/89

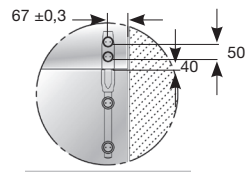
2990.1 IM**UNIÓN DOS LUNAS**

120/83

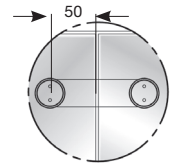
2990.5 IM**PERNIO ALTO**

120/85

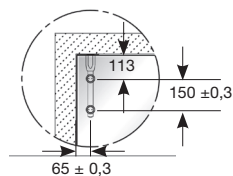
2990.2 IM**UNIÓN TRES LUNAS**

120/93

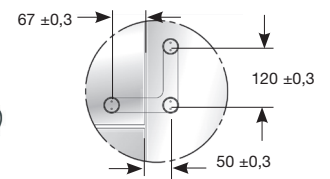
2990.6 IM**PERNIO BAJO
REGLETA ESPAÑOLA (CE)**

120/87

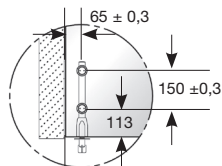
2990.3 IM**PUNTO DE GIRO SUPERIOR**

120/97

2990.9 IM**PUNTO DE GIRO LATERAL MONTANTE**

120/91

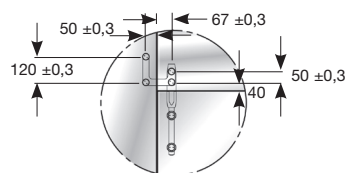
2990.4 IM**SOPORTE FIN PERFIL**

50/68

2992.5 IM

SERIE SV-SWING OVAL

PARA PUERTAS PRACTICABLES

Vidrio 10/12 mm

HERRAJES

SECURIT | SERIE SV-SWING OVAL

SV-SWING OVAL

SV-SWING OVAL es un sistema de divisiones y puertas de vidrio, de puerta batiente, tanto simple como doble, de hasta 120 kg de peso y para vidrios de entre 10 y 12 mm. Sistema de herrajes de acero inoxidable con un acabado de gran calidad, de modo que pueden ser visibles y dar un toque de diseño a la instalación. Diferentes herrajes regulables y articulados que se pueden combinar de múltiples formas. Todos los kits incluyen un juego de 2 bisagras y una cerradura o cerradero.

Acabados:

- Inox mate



Alzado y sección tipo (Cotas en mm)

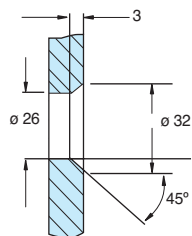

Taladro para todos los herrajes



10/12 mm

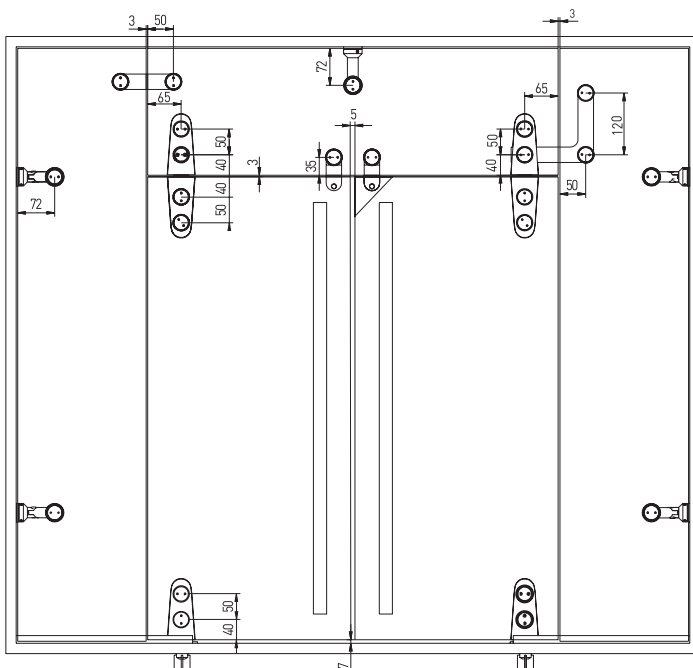

Variantes de instalación:

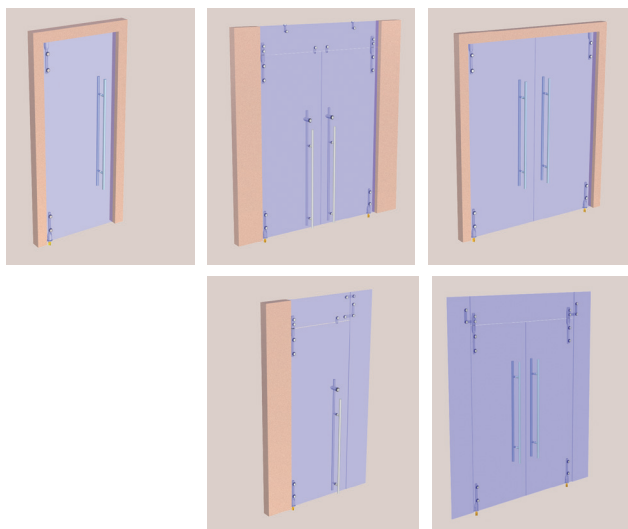



PERNIO ALTO

120/86

2991.1 IM

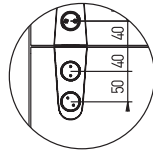

**PERNIO BAJO
REGLETA ESPAÑOLA (CE)**

120/88

2991.2 IM

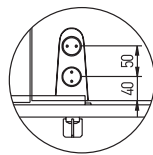

PUNTO DE GIRO MONTANTE

120/90

2991.3 IM

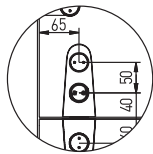
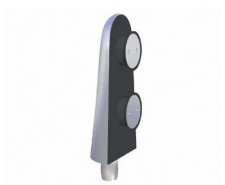

PUNTO DE GIRO LATERAL MONTANTE

120/92

2991.4 IM

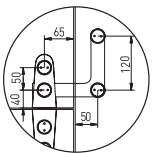

**TOPE FRENO PANEL-VIDRIO
PARA BATIENTE**

120/95

2990.7 IM

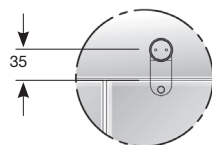

**TEJUELO
REGLETA ESPAÑOLA (CE)**

463N

4156 IM

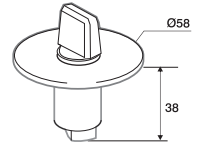

**TOPE FRENO PANEL-TECHO
PARA BATIENTE**

120/96

2990.8 IM



PUNTO DE GIRO SUPERIOR

120/97

2990.9 IM



PIVOTE EXPANSIÓN TECHO

120/98

2990 IM



CERRADURA 70 x110 mm

66/64

Taladro Ø 57 mm
Vidrio 8/10/12 mm

727 IM

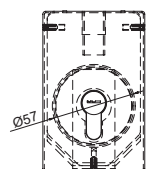

MODELO G100

Vidrio 8 a 13 mm

AISI-316

KIT DE PIVOTE HIDRÁULICO

G100

Características técnicas:

- Kit compuesto por: pernio alto, pernio bajo hidráulico y punto de giro superior.
- Mecanismo provisto de dos velocidades de cierre.
 - 1ª velocidad: de aproximación, actúa de 150° a 10°.
 - 2ª velocidad: de cierre, actúa de 10° a 0°.
- Ancho máximo de la puerta 1000 mm.
- Peso máximo aconsejable de la puerta 100 kg.
- Fluido hidráulico termo constante.
- Punto de inflamación 160°, punto de congelación -40°.

Acabados:

Inox brillo	4031 IB
Inox mate	4031 IM
Negro mate	4031 NE

* Acabados especiales bajo pedido



Ver vídeo demostrativo.
www.vitrum.es



CARGA
MAX.
100 Kg

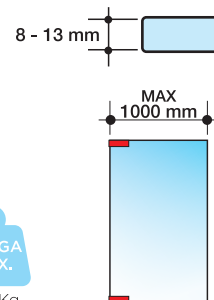

PERNIO ALTO

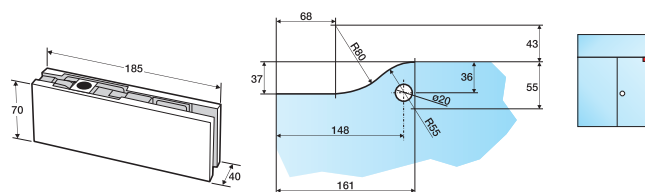

PERNIO BAJO HIDRÁULICO

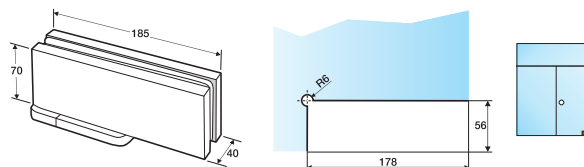

PUNTO DE GIRO SUPERIOR





MODELO G100E

Vidrio 10 a 15 mm

EXTERIORES

AISI-316

KIT DE PIVOTE HIDRÁULICO ESPECIAL PUERTAS EXTERIORES

G100E

Características técnicas:

- Kit compuesto por: pernio alto, pernio bajo
- hidráulico y punto de giro superior
- Certificado Grado 3 (anticorrosión)
- Temperatura de trabajo -20° a +50°
- Con fuerza especial para apertura y cierre 49N que resiste corrientes de viento
- Resiste altas presiones y corrientes de viento
- Certificado EN 1154:1996/A1:2002/AC:2006 (500.000 ciclos)
- Ancho máximo de la puerta 1250 mm
- Peso máximo aconsejable de la puerta 115 kg
- Mecanismo provisto de 2 velocidades de cierre:
 - 1ª velocidad: de aproximación; actúa de 150° a 10°
 - 2ª velocidad: de cierre; actúa de 10° a 0°
- Provisto de retención a 90°
- Fluido hidráulico termo constante. Punto de inflamación 160°, punto de congelación -40°

Acabados:

Inox brillo	4030 IB
Inox mate	4030 IM
Negro mate	4030 NE

* Acabados especiales bajo pedido

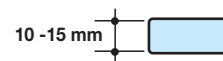

Ver vídeo demostrativo.
www.vitrum.es



115 kg

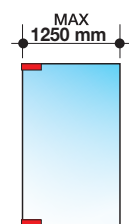

PERNIO ALTO

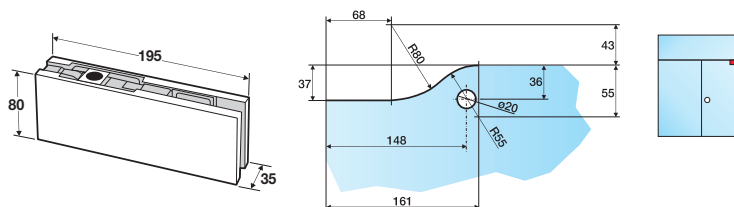

PERNIO BAJO HIDRÁULICO

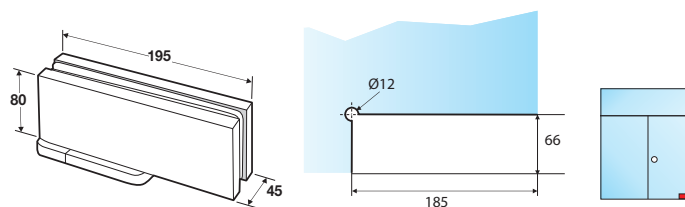

PUNTO DE GIRO SUPERIOR

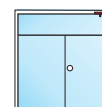

COMPONENTES MODELO G100/G100E

PERNIO - FRENO INFERIOR

Incluido en Ref. 4031

Vidrio 8 a 13 mm

Acabados:

Inox brillo	4032 IB
Inox mate	4032 IM

PERNIO - FRENO INFERIOR EXTERIOR

Incluido en Ref. 4030

Vidrio 8 a 15 mm

Acabados:

Inox brillo	4030.1 IB
Inox mate	4030.1 IM

G100A

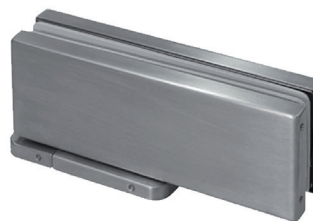

PERNIO ALTO CON TAPAS PEQUEÑAS

Acabados:

Inox brillo	4033 IB
Inox mate	4033 IM

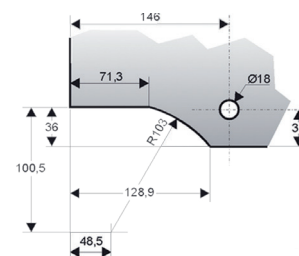
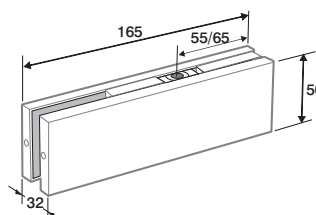

H1001

PUNTO DE GIRO MONTANTE

Acabados:

Inox brillo	4034 IB
Inox mate	4034 IM

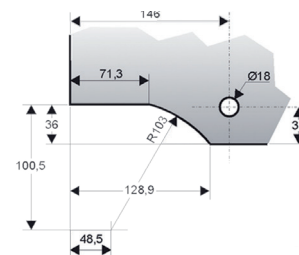
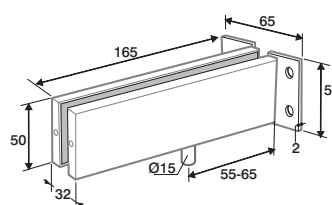

H1003

PUNTO DE GIRO LATERAL MONTANTE

Acabados:

Inox brillo	4035 IB
Inox mate	4035 IM

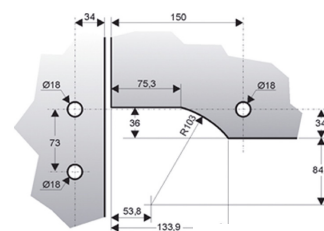
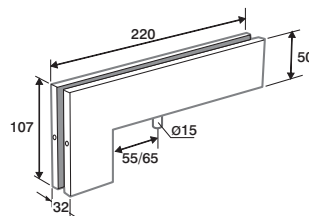

H1004

UNIÓN TRES LUNAS

Acabados:

Inox brillo	4036 IB
Inox mate	4036 IM

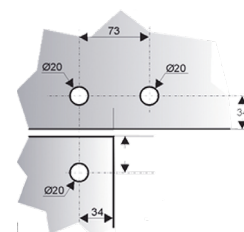
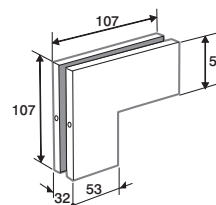

H1005



MODELO HYDRA EVO 2.1

AISI-316

KIT DE PIVOTE HIDRÁULICO

Componentes:

- 1 pernio - freno inferior
- 1 pernio alto
- 1 punto de giro superior
- 1 placa de suelo regulable con kit de fijación

Características:

- Vidrio de 8 a 12,76 mm
- Peso máximo puerta: 100 kg
- Ancho máximo puerta: 1100 mm
- Retención a 90°
- Apertura / cierre 180°
- Base ajustable ± 2 mm
- Ajuste de compensación de puerta cero ±5°
- Doble ajuste de velocidad: de 90° a 20° y de 20° a 0°
- Probado en 500.000 ciclos de apertura

Acabados:

Inox brillo	1552 IB
Inox mate	1552 IM
Negro mate	1552 NE

* Acabados especiales bajo pedido

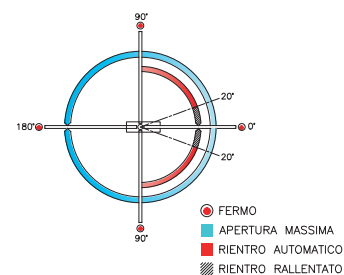

PERNIO SUPERIOR

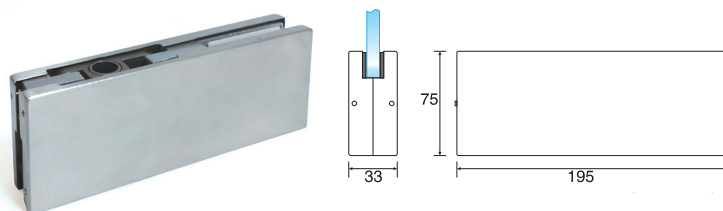

PUNTO DE GIRO

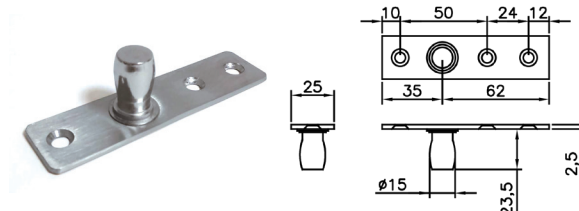

PERNIO INFERIOR

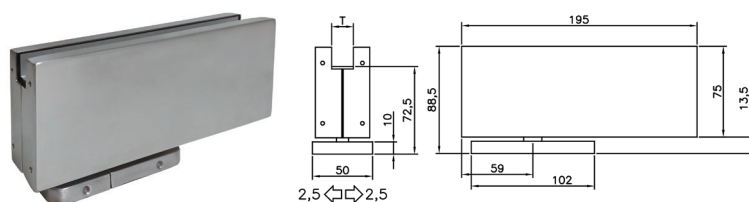

PLACA DE SUELO

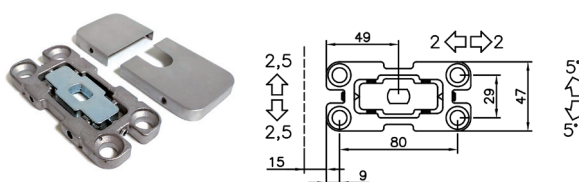

COMPONENTES HYDRA EVO 2.1

PERNIO - FRENO INFERIOR

Incluido en ref. 1552

Vidrio 8 a 12,76 mm

Acabados:

Inox brillo	1553 IB
Inox mate	1553 IM

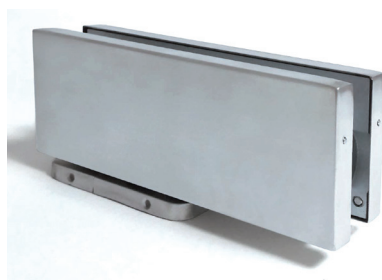

E03A44

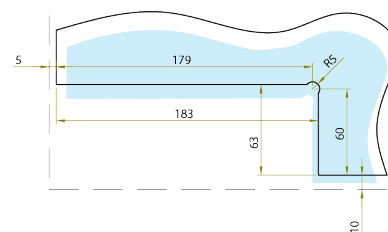

PERNIO ALTO CON TAPAS PEQUEÑAS

Compatible con ref. 1502 y 1505

Vidrio 10/12 mm

Acabados:

Inox brillo	1506 IB
Inox mate	1506 IM



0200181

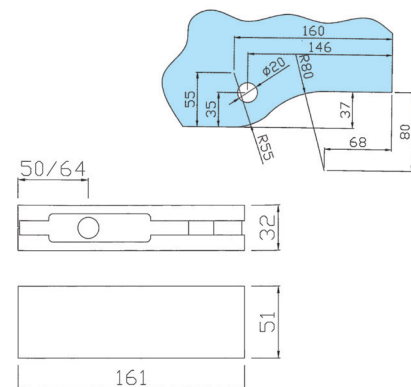

PUNTO DE GIRO MONTANTE

Vidrio 10/12 mm

Acabados:

Inox brillo	1502 IB
Inox mate	1502 IM

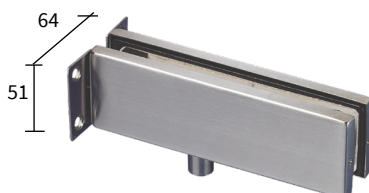

0600181

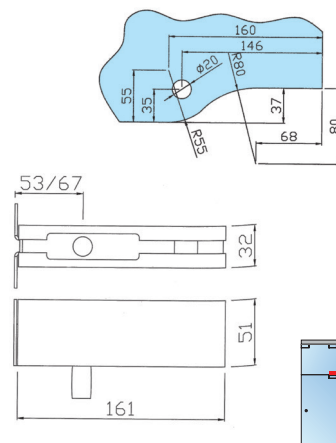

PUNTO DE GIRO LATERAL MONTANTE

Vidrio 10/12 mm

Acabados:

Inox brillo	1505 IB
Inox mate	1505 IM



0400181

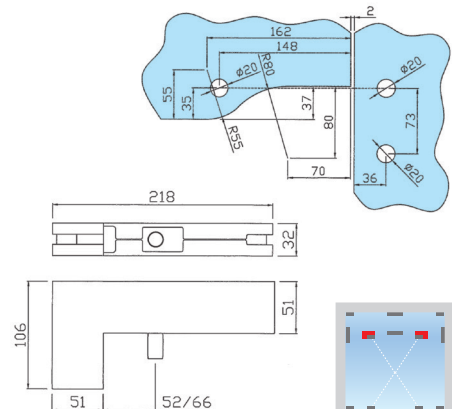



MODELO HYDRA PRO

AISI-316

NOVEDAD

KIT DE PIVOTE HIDRÁULICO

Componentes:

- 1 pernio - freno inferior
- 1 pernio alto
- 1 punto de giro superior
- 1 placa de suelo regulable con kit de fijación

Características:

- Vidrio de 8 a 13,52 mm
- Peso máximo puerta: 100 kg
- Ancho máximo puerta: 1000 mm
- Retención a 90°
- Apertura / cierre 180°
- Doble ajuste de velocidad: de 90° a 20° y de 20° a 0°
- Probado en 500.000 ciclos de apertura

Acabados:

Inox brillo	1554 IB
Inox mate	1554 IM
Negro	1554 NE

* Acabados especiales bajo pedido

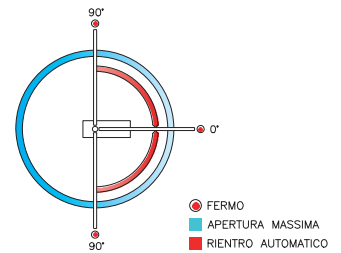

Ver vídeo demostrativo.
www.vitrum.es

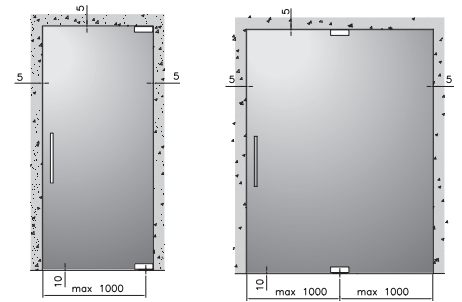
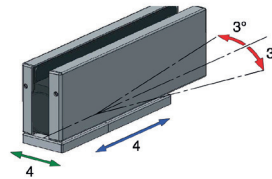

PERNIO SUPERIOR

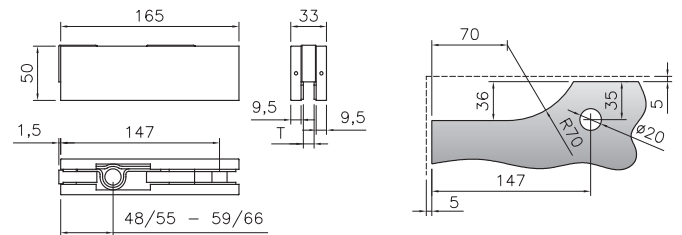

PERNIO INFERIOR

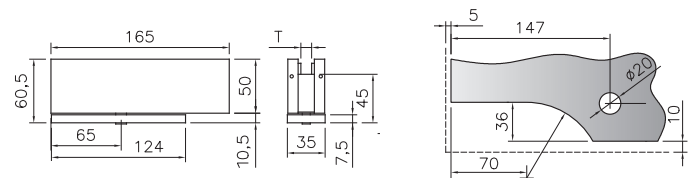

PUNTO DE GIRO

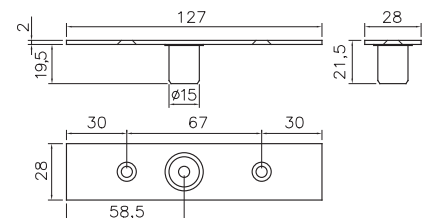

PERNIO ALTO VAIVÉN CARPINTERÍA

140 x 28 mm

MATERIAL: Aleación de latón mediante proceso de estampación

4145

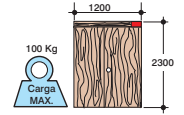
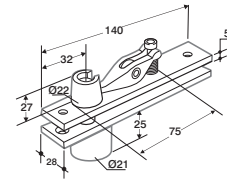
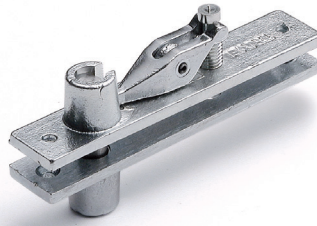

PACV

PERNIO BAJO VAIVÉN CARPINTERÍA

200 x 25 mm

MATERIAL: Aleación de latón mediante proceso de estampación

Cuadrillo italiano	13/16	4146.I
Cuadrillo francés	16/19	4146.S

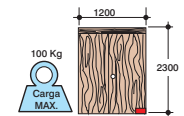
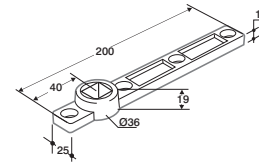

PBCV 13/16
PBCV 16/19

PERNIO ALTO DESPLAZADO

MATERIAL: Aleación de latón mediante proceso de estampación

4147

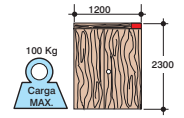
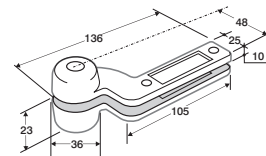

PACD

PERNIO BAJO DESPLAZADO

MATERIAL: Aleación de latón mediante proceso de estampación

Cuadrillo italiano	13/16	4148.I
Cuadrillo francés	16/19	4148.S

*Indícanos la mano

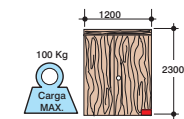
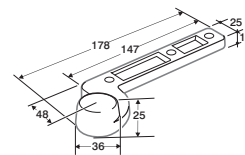

PBCD

2.3 - HERRAJES PARA CARPINTERIA



PERNIO BAJO CARPINTERÍA PARA EJE ITALIANO MAB

3185

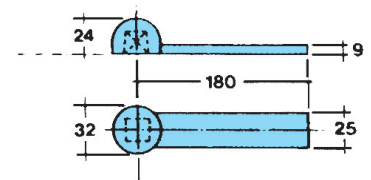

AC2L

PERNIO ALTO CARPINTERÍA MAB

3186

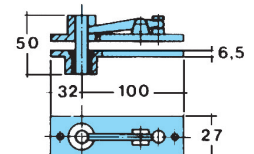
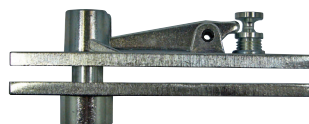

AC8A



SERIE (T)

Vidrio 10 mm

TOPE PRESIÓN SIMPLE

40 x 55 mm

Acabados:

Inox brillo	4089 IB
Inox mate	4089 IM

* Para otros espesores, consúltanos

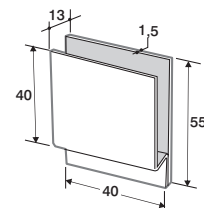
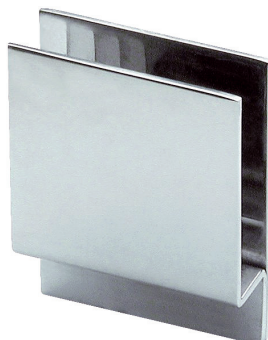

TP1

TOPE PRESIÓN DOBLE

80 x 55 mm

Acabados:

Inox brillo	4090 IB
Inox mate	4090 IM

* Para otros espesores, consúltanos

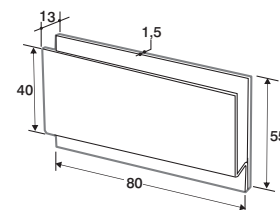
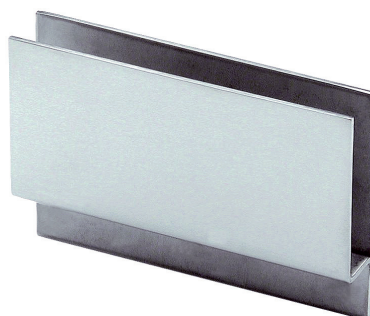

TP2

TOPE CARPINTERÍA

50 x 25 x 17 mm

Acabados:

Inox brillo	4091 IB
Inox mate	4091 IM

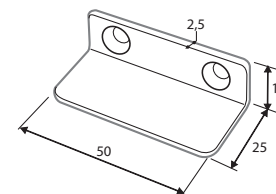

TP3

TOPE PUERTA LATÓN

44 x 26 mm

Acabados:

Plata brillo	690 PB
--------------	--------

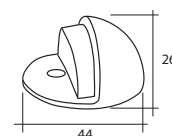

TOPE PUERTA

Acabados:

Inox mate	5717 IM
-----------	---------

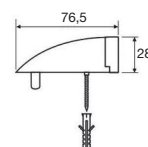

TOPE PUERTA

Acabados:

Inox mate	5718 IM
-----------	---------

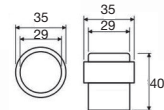

TOPE PUERTA

Acabados:

Inox mate	5719 IM
-----------	---------

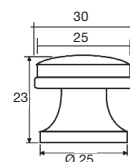

INOX-304
Vidrio 10 a 25 mm
PLINTO ALTO SIN CERRADURA
Acabados:

Inox brillo	4045 IB
Inox mate	4045 IM

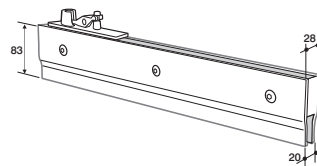
 PLA
PLAC

PLINTO ALTO CON CERRADURA
Acabados:

Inox brillo	4046 IB
Inox mate	4046 IM

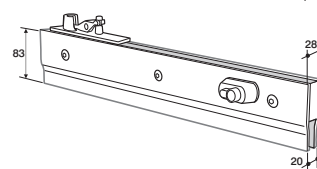
PLINTO BAJO SIN CERRADURA

Eje regleta

Acabados:

Inox brillo	4047 IB
Inox mate	4047 IM

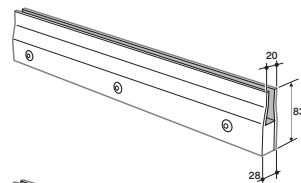

 PLB
PLBC

PLINTO BAJO CON CERRADURA

Eje regleta

Acabados:

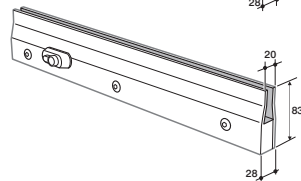
Inox brillo	4048 IB
Inox mate	4048 IM

PLINTO LATERAL
Acabados:

Inox brillo	4049 IB
Inox mate	4049 IM

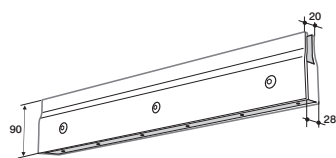

PLL

PLINTO - FABRICACIÓN ESTÁNDAR

Para anchos de puerta hasta 1100 mm

Espesores de vidrio de 10 a 12 mm

Especificar el espesor del vidrio en el pedido

Medidas a descontar para el acoplamiento del plinto:

- De la altura del hueco de la puerta descontar 110 mm, se obtiene la holgura superior e inferior. De la altura resultante se tiene que descontar 1100 mm para el acople del plinto superior y plinto inferior (vidrio de 10 a 12 mm)
- Del ancho del hueco de la puerta descontar 8 mm de holgura lateral (en puertas dobles descontar 12 mm), con ello se tiene la medida final de la puerta.

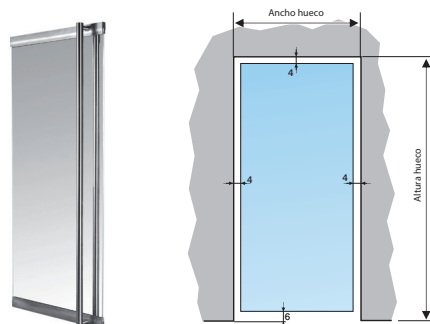
TIRADOR PARA PLINTO

Para poder instalar el tirador en el plinto, éste debe ser solicitado al pedido del mismo.

Los tiradores sólo se pueden montar en los plintos que estén fabricados especialmente para ello, por lo cual el pedido del tirador y del plinto debe ser simultáneo.

*Para otras medidas, consúltanos.

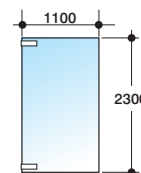

INOX

AISI-304 O AISI-316

PLINTOS INOX

Los plintos inox se caracterizan por facilitar enormemente las instalaciones con vidrio laminado, tanto de puertas como de fijos + puertas

AISI-304 O AISI-316

Vidrio 10 a 18 mm

Adaptación al hueco preexistente. Ancho a medida.

Cerradura inferior de pestillo con cerradero empotrable en el suelo.

Cerradero de palanca incluido en el plinto para instalaciones de puertas auxiliares que no necesitan cerrarse desde fuera.

Instalación de tiradores sujetos al plinto superior e inferior sin agujeros en el vidrio.

Altura máxima 3,5 m.

Adaptación a cualquier tipo de freno o instalación con tejuelo. Punto de giro inferior con alojamiento + bola de acero Ø 10 mm.

Punto de giro superior desmontable para facilitar su instalación. Alojamiento empotrable en marco incluido.

Eje Regleta española. Adaptación a otros ejes, consúltanos.

Ancho máximo de vidrio 1100 mm.

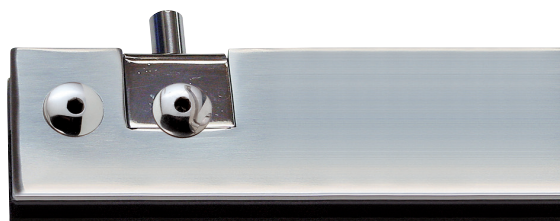

PLINTO CON CERRADURA

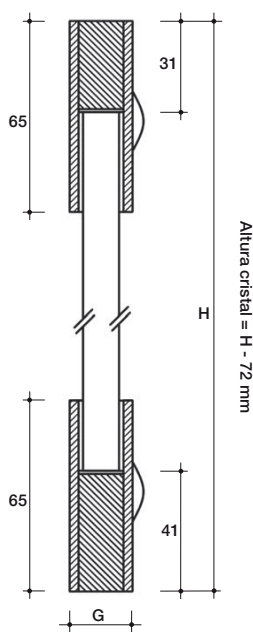

G = según cristal

Ejemplo:

Para cristal 6+6 G = 21 mm
Para cristal 6+6+6 G = 26 mm

PLINTO SIN CERRADURA

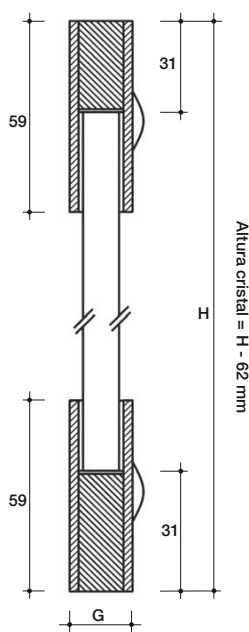

G = según cristal

Ejemplo:

Para cristal 6+6 G = 21 mm
Para cristal 6+6+6 G = 26 mm

Acabados:

Inox brillo	5045 IB
Inox mate	5045 IM

¿CÓMO PEDIR UN JUEGO DE PLINTOS?

Indícanos:

- Ancho de la puerta
- Espesor del vidrio
- Sentido de apertura de la puerta
- Acabado brillo o mate
- Tipo de freno sobre el que se instalará
- También puede suministrarse con el freno adecuado
- ¿Con cerraduras? ¿Tipo?
- ¿Con tirador? ¿Tipo? En este caso indicar altura de la puerta
- Dimensiones de la puerta respecto al hueco.
- Ancho: descontar 4 mm a cada lado
- Altura: descontar 4 mm (plinto superior) + 8 mm (plinto inferior) + 62 mm (armazón en caso de plinto sin cerradura) + 72 mm (armazón en caso de plinto con cerradura)