



un secolo di idee per l'agricoltura



Elevatori idraulici
Hydraulic fork-lifts
Elevateurs hidrauliques

 **Elevatore idraulico tipo Duplex**
Montanti in speciale acciaio estruso

PRINCIPALI CARATTERISTICHE

- Forche in acciaio ribaltabili e registrabili in larghezza
- Montanti in speciale acciaio estruso (profilo CC)
- Sollevamento con martinetto idraulico a doppio effetto
- Valvola di sicurezza nei martinetti del sollevamento e del brandeggio
- Scorrimento su rulli con boccole autolubrificanti

Modelli disponibili con:

2 MOVIMENTI IDRAULICI (senza distributore)

Sollevamento / brandeggio

3 MOVIMENTI IDRAULICI (con distributore)

Sollevamento / brandeggio / traslatore / predisposizione per 4° movimento (stringicassa, rovesciatore idraulico e vasca in acciaio)

 **Hydraulic fork-lift, type Duplex**
Struts in special extruded steel

MAIN SPECIFICATIONS

- Tipping steel forks, adjustable in width
- Struts in special extruded steel (profile CC)
- Hydraulic jacking lifting (double effect)
- Hydraulic jacking lifting and derricking with security valve
- Sliding on rollers with self-lubricating bushings

Available models with:

2 HYDRAULIC MOVEMENTS (without distributor)

Lifting/ derricking

3 HYDRAULIC MOVEMENTS (with distributor)

Lifting/derricking/shifting/ predisposition for fourth movement (case-holding press, hydraulic tipper and steel tank)

 **Elevateur hidraulique type Duplex**
Montant en spécial acier extrudé

CARACTÉRISTIQUES PRINCIPALES

- Fourches en acier réversible et réglables en largeur
- Montant en spécial acier extrudé (profil CC)
- Soulèvement avec vérin hydraulique à double effet
- Soupape de sûreté dans les vérin du soulèvement et du pivotement
- Glissement sur rouleaux avec boucles autolubrifiantes

Modèles disponibles avec:

2 MOUVEMENTS HYDRAULIQUES (sans distributeur)

Soulèvement / Pivotement

3 MOUVEMENTS HYDRAULIQUES (avec distributeur)

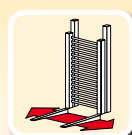
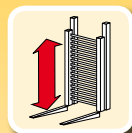

Soulèvement / Pivotement / Translateur /Prédispositions au 4ème LEVIER (serre-caisses, renverseur hydraulique et châssis avec renversement hydraulique)

SERIE **SDC**

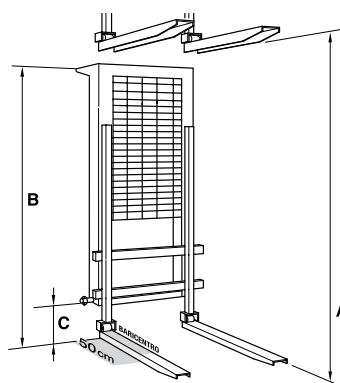
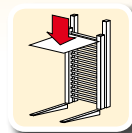

OPTIONAL



| Mod |  | A cm | B cm | C cm |  Kg |
|------------|---------------------------------------------------------------------------------------|---------|---------|---------|------------------------------------------------------------------------------------------|
| SDC 12/200 | 1200 | 200 | 175 | 30 | 315 |
| SDC 12/250 | 1200 | 250 | 200 | 30 | 330 |
| SDC 12/320 | 1200 | 320 | 230 | 30 | 350 |
| SDC 15/200 | 1500 | 200 | 175 | 30 | 350 |
| SDC 15/250 | 1500 | 250 | 200 | 30 | 370 |
| SDC 15/320 | 1500 | 320 | 230 | 30 | 400 |
| SDC 15/360 | 1500 | 360 | 255 | 30 | 425 |

 **Elevatore idraulico tipo Duplex**
Montanti in speciale acciaio estruso

PRINCIPALI CARATTERISTICHE

- Forche in acciaio ribaltabili e registrabili in larghezza (modd. SDCH17) oppure forche regolabili FEM (modd. SDCH 20)
- Montanti in speciale acciaio estruso (profilo CH)
- Sollevamento con martinetto idraulico a doppio effetto
- Valvola di sicurezza nei martinetti del sollevamento e del brandeggio
- Scorrimento su cuscinetti a rulli

Modelli disponibili con:

2 MOVIMENTI IDRAULICI (senza distributore)
Sollevamento / brandeggio

3 MOVIMENTI IDRAULICI (con distributore)
Sollevamento / brandeggio / traslatore / predisposizione per 4° movimento (stringicassa, rovesciatore idraulico e vasca in acciaio)

 **Hydraulic fork-lift, type Duplex**
Struts in special extruded steel

MAIN SPECIFICATIONS

- Tipping steel forks, adjustable in width (modd. SDCH17) or FEM adjustable forks (modd. SDCH20)
- Struts in special extruded steel (profile CH)
- Hydraulic jacking lifting (double effect)
- Hydraulic jacking lifting and derricking with security valve
- Sliding on roller bearings

Available models with:

2 HYDRAULIC MOVEMENTS (without distributor)
Lifting/ derricking

3 HYDRAULIC MOVEMENTS (with distributor)
Lifting/derricking/shifting/ predisposition for fourth movement (case-holding press, hydraulic tipper and steel tank)

 **Elevateur hidraulique type Duplex**
Montant en spécial acier extrudé

CARACTÉRISTIQUES PRINCIPALES

- Fourches en acier réversible et réglables en largeur (modd. SDCH17) ou fourches réglables FEM (modd. SDCH 20)
- Montant en spécial acier extrudé (profil CH)
- Soulèvement avec vérin hydraulique à double effet
- Soupape de sûreté dans les vérin du soulèvement et du pivotement
- Glissement sur roulement à rouleaux

Modèles disponibles avec:

2 MOUVEMENTS HYDRAULIQUES (sans distributeur)
Soulèvement / Pivotement

3 MOUVEMENTS HYDRAULIQUES (avec distributeur)
Soulèvement / Pivotement / Translateur /Prédispositions au 4ème LEVIER (serre-caisses, renverseur hydraulique et châssis avec renversement hydraulique)

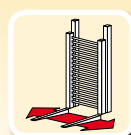
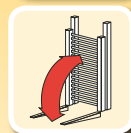
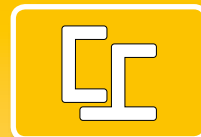

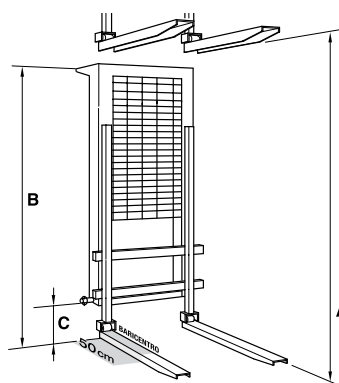
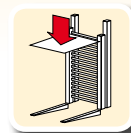

OPTIONAL

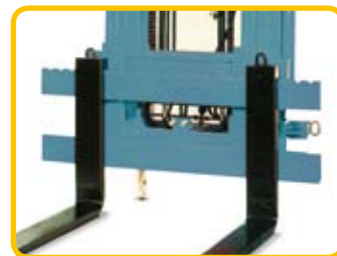

Forche regolabili FEM.
FEM adjustable forks.
Fourches réglables FEM.

SDCH 20/320... 20/360... 20/400



| Mod |  | A cm | B cm | C cm |  Kg |
|--------------|---------------------------------------------------------------------------------------|---------|---------|---------|------------------------------------------------------------------------------------------|
| SDCH 17/250 | 1700 | 250 | 200 | 30 | 400 |
| SDCH 17/320 | 1700 | 320 | 230 | 30 | 430 |
| SDCH 17/360 | 1700 | 360 | 255 | 30 | 460 |
| SDCH 17/400 | 1700 | 400 | 280 | 30 | 490 |
| SDCH 20/320* | 2000 | 320 | 235 | 30 | 608 |
| SDCH 20/360* | 2000 | 360 | 260 | 30 | 635 |
| SDCH 20/400* | 2000 | 400 | 285 | 30 | 670 |

* Forche regolabili FEM/ FEM adjustable forks/ Fourches réglables FEM

 **Elevatore idraulico tipo Duplex**
Montanti in speciale acciaio estruso

PRINCIPALI CARATTERISTICHE

- Forche in acciaio ribaltabili e regolabili in larghezza (modd. SDHL17) oppure forche regolabili FEM (modd. SDHL 20)
- Montanti in speciale acciaio estruso (profilo HH)
- Sollevamento con due martinetti idraulici a doppio effetto
- Valvola di sicurezza nei martinetti del sollevamento e del brandeggio
- Scorrimento su cuscinetti a rulli

Modelli disponibili con:

3 MOVIMENTI IDRAULICI (con distributore)

Sollevamento/brandeggio/traslatore/predisposizione per 4° movimento (stringicassa, rovesciatore idraulico e vasca in acciaio)

 **Hydraulic fork-lift, type Duplex**
Struts in special extruded steel

MAIN SPECIFICATIONS

- Tipping steel forks, adjustable in width (modd. SDHL17) or FEM adjustable forks (modd. SDHL20)
- Struts in special extruded steel (profile HH)
- Double hydraulic jacking lifting (double effect)
- Hydraulic jacking lifting and derricking with security valve
- Sliding on roller bearings

Available models with:

3 HYDRAULIC MOVEMENTS (with distributor)

Lifting/derricking/shifting/ predisposition for fourth movement (case-holding press, hydraulic tipper and steel tank)

 **Elevateur hidraulique type Duplex**
Montant en spécial acier extrudé

CARACTÉRISTIQUES PRINCIPALES

- Fourches en acier réversible et réglables en largeur (modd. SDHL17) ou fourches réglables FEM (modd. SDHL 20)
- Montant en spécial acier extrudé (profil HH)
- soulèvement avec vérin hydraulique à double effet
- Soupape de sûreté dans les vérin du soulèvement et du pivotement
- Glissement sur roulement à rouleaux

Modèles disponibles avec:

3 MOUVEMENTS HYDRAULIQUES (avec distributeur)

Soulèvement / Pivotement / Translateur /Predispositions au 4ème LEVIER (serre-caisses, renverseur hydraulique et châssis avec renversement hydraulique)

SERIE **SDHL**

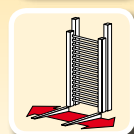
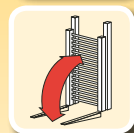
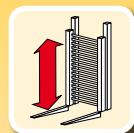
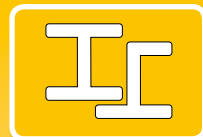

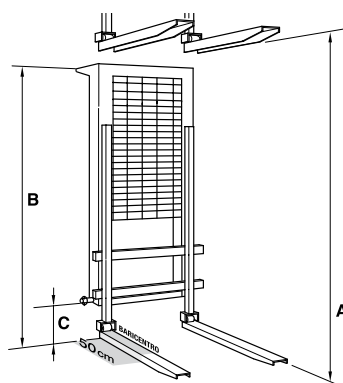
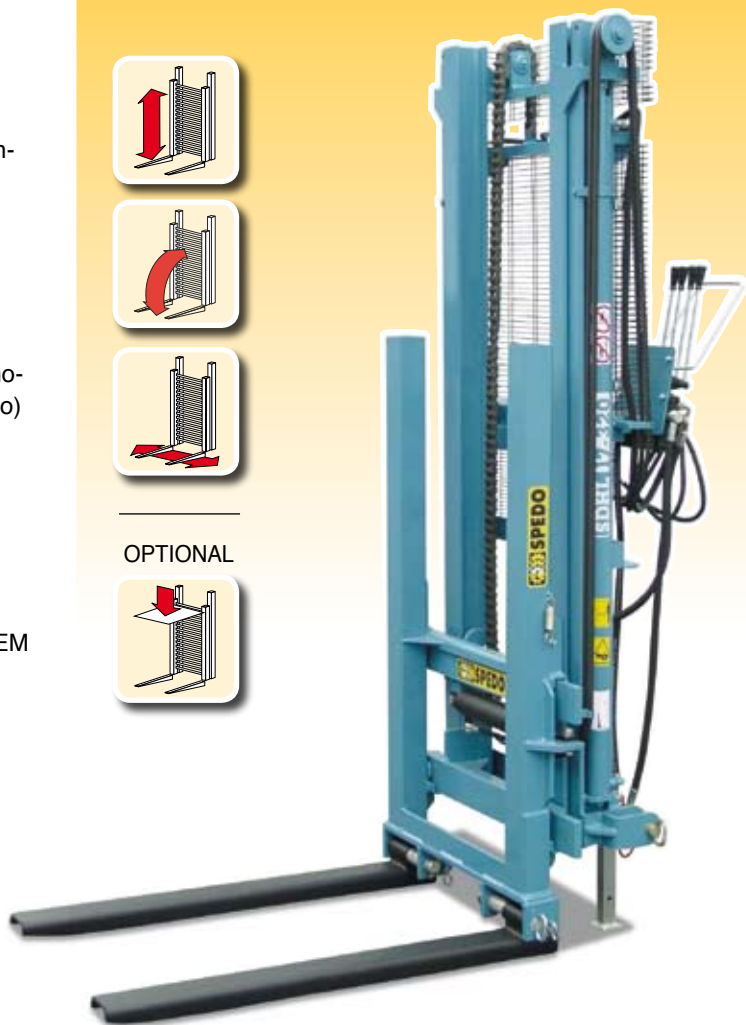
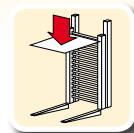

OPTIONAL

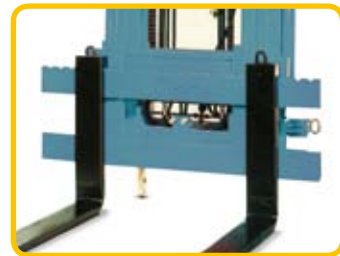

Forche regolabili FEM.
FEM adjustable forks.
Fourches réglables FEM.

SDHL 20/320... 20/360... 20/400



| Mod |  | A cm | B cm | C cm |  Kg |
|--------------|---------------------------------------------------------------------------------------|---------|---------|---------|------------------------------------------------------------------------------------------|
| SDHL 17/250 | 1700 | 250 | 200 | 30 | 410 |
| SDHL 17/320 | 1700 | 320 | 230 | 30 | 450 |
| SDHL 17/360 | 1700 | 360 | 255 | 30 | 480 |
| SDHL 17/400 | 1700 | 400 | 280 | 30 | 510 |
| SDHL 20/320* | 2000 | 320 | 235 | 30 | 628 |
| SDHL 20/360* | 2000 | 360 | 260 | 30 | 655 |
| SDHL 20/400* | 2000 | 400 | 285 | 30 | 690 |

* Forche regolabili FEM/ FEM adjustable forks/ Fourches réglables FEM

 **Elevatore idraulico tipo Triplex**
Montanti in speciale acciaio estruso

PRINCIPALI CARATTERISTICHE

- Forche in acciaio ribaltabili e registrabili in larghezza
- Montanti in speciale acciaio estruso (profilo CCC)
- Sollevamento con martinetto idraulico
- Valvola di sicurezza nei martinetti del sollevamento e del brandeggio
- Scorrimento su rulli con boccole autolubrificanti

Modelli disponibili con:

Modelli disponibili con:

2 MOVIMENTI IDRAULICI (senza distributore)
Sollevamento / brandeggio

3 MOVIMENTI IDRAULICI (con distributore)
Sollevamento/brandeggio/traslatore/predisposizione per 4° movimento (stringicassa, rovesciatore idraulico e vasca in acciaio)

 **Hydraulic fork-lift, type Triplex**
Struts in special extruded steel

MAIN SPECIFICATIONS

- Tipping steel forks, adjustable in width
- Struts in special extruded steel (profile CCC)
- Hydraulic jacking lifting
- Hydraulic jacking lifting and derricking with security valve
- Sliding on rollers with self-lubricating bushings

Available models with:

2 HYDRAULIC MOVEMENTS (without distributor)
Lifting/ derricking

3 HYDRAULIC MOVEMENTS (with distributor)
Lifting/derricking/shifting/ predisposition for fourth movement (case-holding press, hydraulic tipper and steel tank)

 **Elevateur hidraulique type Triplex**
Montant en spécial acier extrudé

CARACTÉRISTIQUES PRINCIPALES

- Fourches en acier réversible et réglables en largeur
- Montant en spécial acier extrudé (profil CCC)
- Soulèvement avec vérin hydraulique
- Soupape de sûreté dans les vérin du soulèvement et du pivotement
- Glissement sur rouleaux avec boucles autolubrifiantes

Modèles disponibles avec:

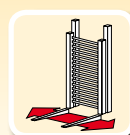
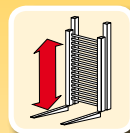

2 MOUVEMENTS HYDRAULIQUES (sans distributeur)
Soulèvement / Pivotement

3 MOUVEMENTS HYDRAULIQUES (avec distributeur)
Soulèvement / Pivotement / Translateur /Predispositions au 4ème LEVIER (serre-caisses, renverseur hydraulique et châssis avec renversement hydraulique)

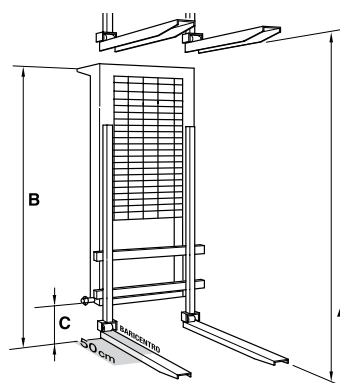
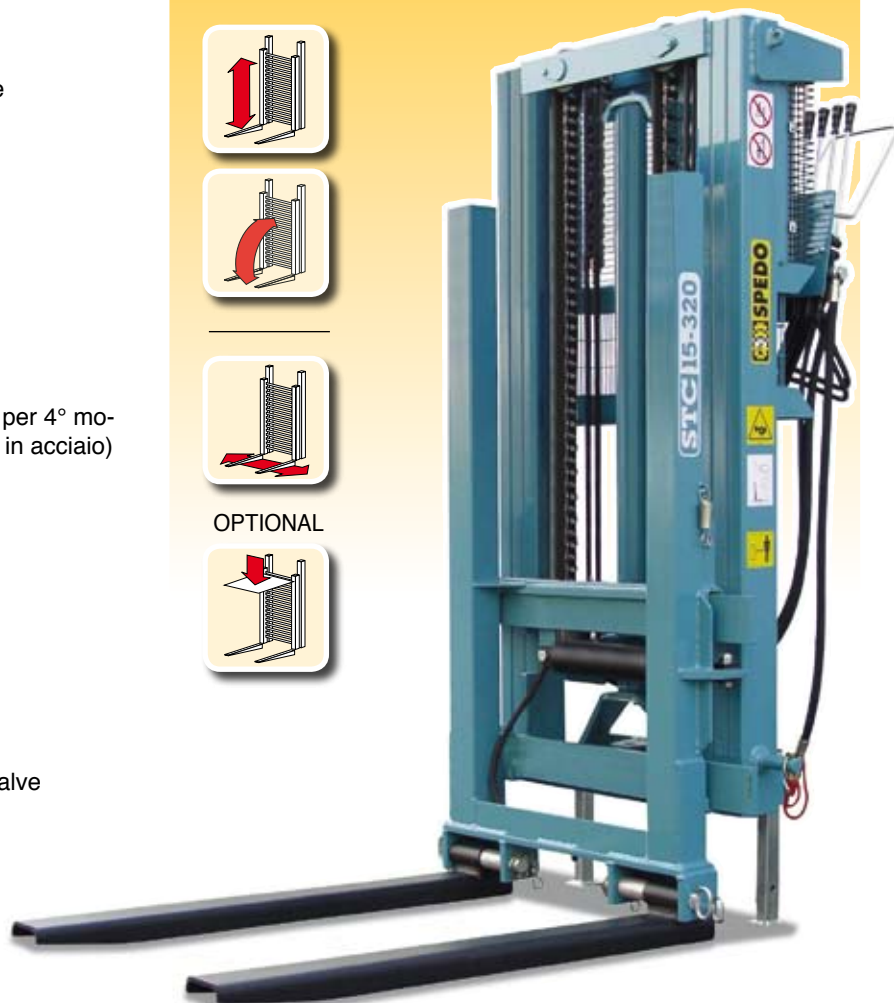
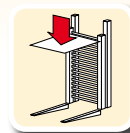

OPTIONAL



| Mod |  | A cm | B cm | C cm |  Kg |
|------------|---------------------------------------------------------------------------------------|---------|---------|---------|------------------------------------------------------------------------------------------|
| STC 10/250 | 1000 | 250 | 150 | 25 | 335 |
| STC 10/320 | 1000 | 320 | 175 | 25 | 365 |
| STC 15/250 | 1500 | 250 | 155 | 25 | 385 |
| STC 15/320 | 1500 | 320 | 180 | 25 | 420 |
| STC 15/380 | 1500 | 380 | 210 | 30 | 445 |

 **Elevatore idraulico tipo Triplex con
“ALZATA LIBERA”
Montanti in speciale acciaio estruso**

PRINCIPALI CARATTERISTICHE

- L' *alzata libera* consente di sollevare il carico di 20 cm mantenendo inalterato l'ingombro dell'elevatore
- Blocca-casse idraulico
- Forche in acciaio forgiato, ribaltabili e registrabili in larghezza
- Montanti in speciale acciaio estruso (profilo CHH)
- Sollevamento con martinetto
- Valvola di sicurezza nei martinetti del sollevamento e del brandeggio
- Scorrimento su cuscinetti a rulli

Modelli disponibili con:

- 4 MOVIMENTI IDRAULICI** (con distributore)
Sollevamento/brandeggio/traslatore/stringicassa

 **Hydraulic fork-lift, type Triplex with
“FREE RISING”
Struts in special extruded steel**

MAIN SPECIFICATIONS

- *Free rising* allows to lift the load keeping unchanged the overall dimension
- Hydraulic Case-blocker
- Tipping forged steel forks, adjustable in width
- Struts in special extruded steel (profil CHH)
- Hydraulic jacking lifting
- Hydraulic jacking lifting and derriking with security valve
- Sliding on roller bearings

Available models with:

- 4 HYDRAULIC MOVEMENTS** (with distributor)
Lifting/derriking/shifting/ case-holding press

 **Elevateur hydraulique type Triplex avec
“LEVEE LIBRE”
Montant en spécial acier extrudé**



CARACTÉRISTIQUES PRINCIPALES

- La *Levée libre* permet de soulever le chargement 20 cm en maintenant inaltéré l'encombre de l'élévateur
- Serre-caisses hydraulique
- Fourches en acier forgées, réversible et réglables en largeur
- Montant en spécial acier extrudé (profil CHH)
- Soulèvement avec vérin hydraulique
- Soupape de sûreté dans les vérin du soulèvement et du pivotement
- Glissement sur roulement à rouleaux

Modèles disponibles avec:

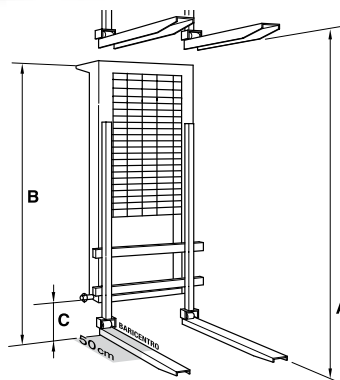
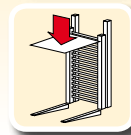
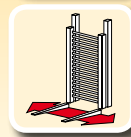
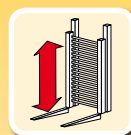
- 4 MOUVEMENTS HYDRAULIQUES** (avec distributeur)
Soulèvement / Pivotement / Translateur / Serre-caisses



| Mod |  | A cm | B cm | C cm |  Kg |
|-------------|---------------------------------------------------------------------------------------|---------|---------|---------|------------------------------------------------------------------------------------------|
| STCH 16/250 | 1600 | 250 | 145 | 22 | 480 |
| STCH 16/320 | 1600 | 320 | 170 | 22 | 520 |

 **Elevatore idraulico tipo Triplex**
Montanti in speciale acciaio estruso

PRINCIPALI CARATTERISTICHE

- Forche in acciaio ribaltabili e registrabili in larghezza
- Montanti in speciale acciaio estruso (profilo HHH)
- Sollevamento con due martinetti idraulici a doppio effetto
- Valvola di sicurezza nei martinetti del sollevamento e del brandeggio
- Scorrimento su cuscinetti a rulli

Modelli disponibili con:

3 MOVIMENTI IDRAULICI (con distributore)

Sollevamento/brandeggio/traslatore/predisposizione per 4° movimento (stringicassa, rovesciatore idraulico e vasca in acciaio)

 **Hydraulic fork-lift, type Triplex**
Struts in special extruded steel

MAIN SPECIFICATIONS

- Tipping steel forks, adjustable in width
- Struts in special extruded steel (profile HHH)
- Double hydraulic jacking lifting (double effect)
- Hydraulic jacking lifting and derricking with security valve
- Sliding on roller bearings

Available models with:

3 HYDRAULIC MOVEMENTS (with distributor)

Lifting/derricking/shifting/ predisposition for fourth movement (case-holding press, hydraulic tipper and steel tank)

 **Elevateur hidraulique type Triplex**
Montant en spécial acier extrudé

CARACTÉRISTIQUES PRINCIPALES

- Fourches en acier réversible et réglables en largeur
- Montant en spécial acier extrudé (profil HHH)
- Soulèvement avec vérin hydraulique à double effet
- Soupape de sûreté dans les vérin du soulèvement et du pivotement
- Glissement sur roulement à rouleaux

Modèles disponibles avec:

3 MOUVEMENTS HYDRAULIQUES (avec distributeur)

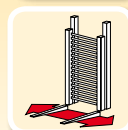
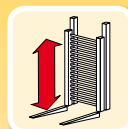
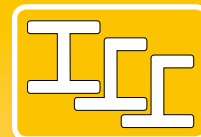

Soulèvement / Pivotement / Translateur /Predispositions au 4ème LEVIER (serre-caisses, renverseur hydraulique et châssis avec renversement hydraulique)

SERIE **STHL**

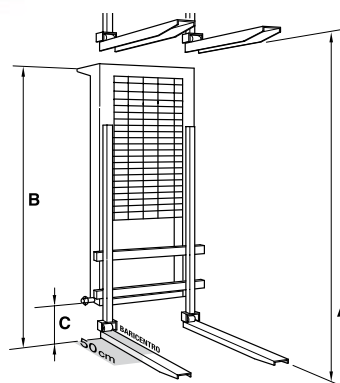
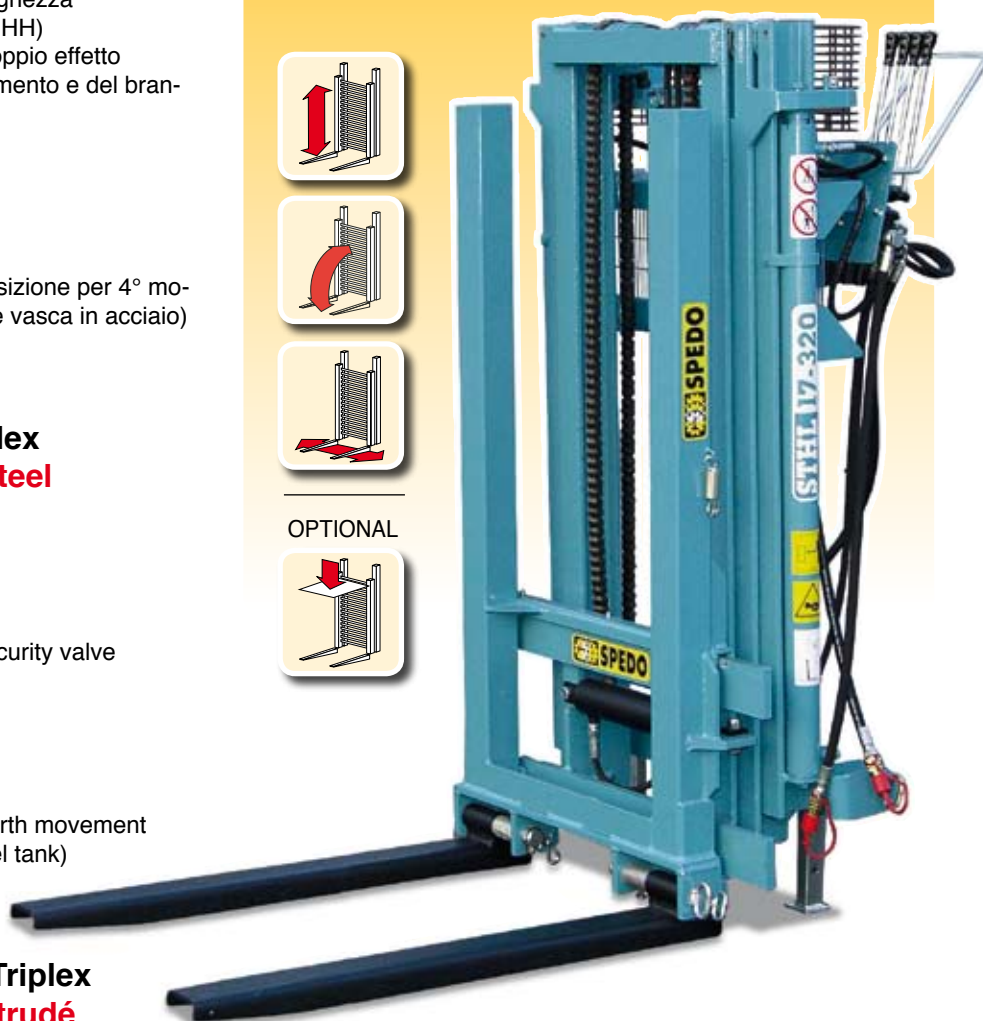
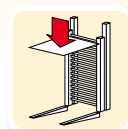

OPTIONAL



| Mod |  | A cm | B cm | C cm |  |
|-------------|---------------------------------------------------------------------------------------|---------|---------|---------|---------------------------------------------------------------------------------------|
| STHL 17/250 | 1700 | 250 | 140 | 20 | 440 |
| STHL 17/320 | 1700 | 320 | 164 | 25 | 500 |
| STHL 17/360 | 1700 | 360 | 195 | 30 | 535 |

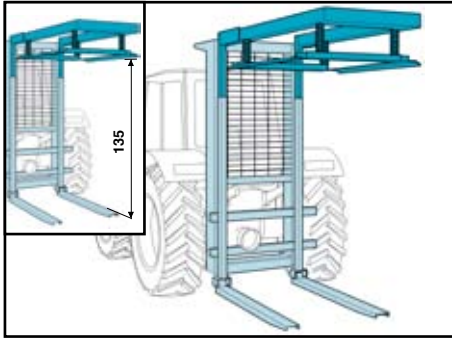

Stringicasse idraulico
Hydraulic case-holding press
Serre-caisses hydraulique

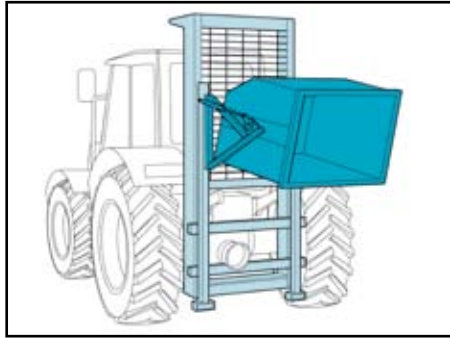

Vasca in acciaio inox con telaio per ribaltamento idra.
Stainless steel tank (frame with hydraulic overturning)
Châssis avec renversement hydraulique



Rovesciatore idraulico con stringicarico lat. e sup.
Hydraulic tippers with side and top load press
Renverseur hydraulique latéral et supérieur

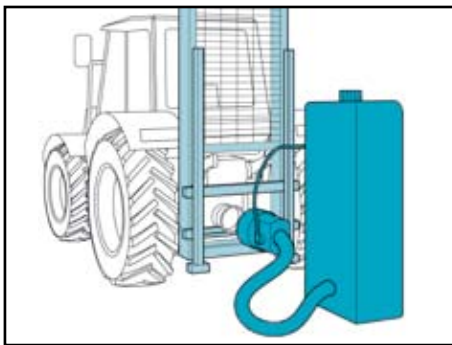

Impianto idraulico indipendente
Self contained hydraulic system
Hydraulique indépendant



Forche regolabili FEM
Adjustable FEM forks
Fourches réglables FEM

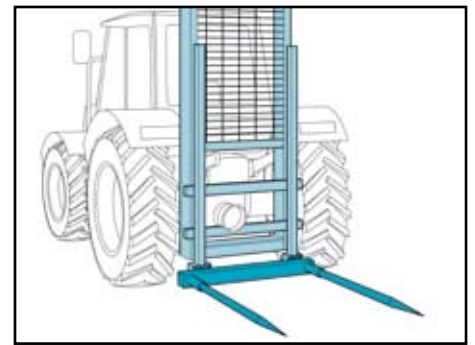

Punte per rotoballe (complete di supporto)
Round bales point (with support set)
Pointes pour balles (avec support)

ACCESSORI

Distributore idraulico a 2 leve
Selettore elettrico a 3 o 4 movimenti
Forche pieghevoli in acciaio
Forche regolabili FEM2 100x35x1000 con piastra
Impianto idraulico indipendente (pompa + serbatoio)
Punte per rotoballe (complete di supporto)
Rovesciatore idraulico con stringicarico laterale e superiore - portata max kg 800 o kg 1500
Stringicasse idraulico
Vasca in acciaio inox con telaio per ribaltamento idraulico - portata max 900 litri
Doppio brandeggio per staffatura anteriore

ACCESSORIES

Hydraulic distributor 2 movements
Electrical selector 3 or 4 movements
Folding steel forks
Adjustable FEM2 forks 100x35x1000 with plates
Self contained hydraulic system (pump + tank)
Round bales point (with support set)
Hydraulic tippers with side and top load press - payload max kg 800 or kg 1500
Hydraulic case-holding press
Stainless steel tank (frame with hydraulic overturning) - payload max 900 lt
Double derricking for front bracket

ACCESSOIRES

Distributeur hydraulique pour 2 mouvement
Commandes électriques à 3 ou 4 mouvements
Fourches pliables en acier
Fourches réglables FEM2 100x35x1000 avec plaque
Hydraulique indépendant (pompe+réservoir)
Pointes pour balles (avec support)
Renverseur hydraulique latéral et supérieur - portée max. kg 800 ou kg 1500
Serre-caisses hydraulique
Châssis avec renversement hydraulique - portée max. litres 900
Double pivotement pour étrier antérieur

Dati, descrizioni ed illustrazioni, sono forniti a puro titolo indicativo e non impegnativo. A.SPEDO & FIGLI SRL si riserva il diritto di apportare modifiche senza obbligo di preavviso. / Characteristics and descriptions are given as information and are not binding. A.SPEDO & FIGLI SRL reserve the right to revise or improve datas without notice / Données, descriptions et illustrations sont fournies à titre d'indication. A.SPEDO & FIGLI SRL se réserve le droit de modifier sans préavis.



un secolo di idee per l'agricoltura

A.SPEDO & FIGLI SRL

Via Bovazecchino, 674

45021 BADIA POLESINE (RO) - Italy

Tel. (+39) 0425 51471 - 0425 52205 Fax (+39) 0425 590650

www.spedo.eu - info@spedo.eu