

SIDE HANDLES
POIGNÉES LATÉRALES
SEITENHENKEL

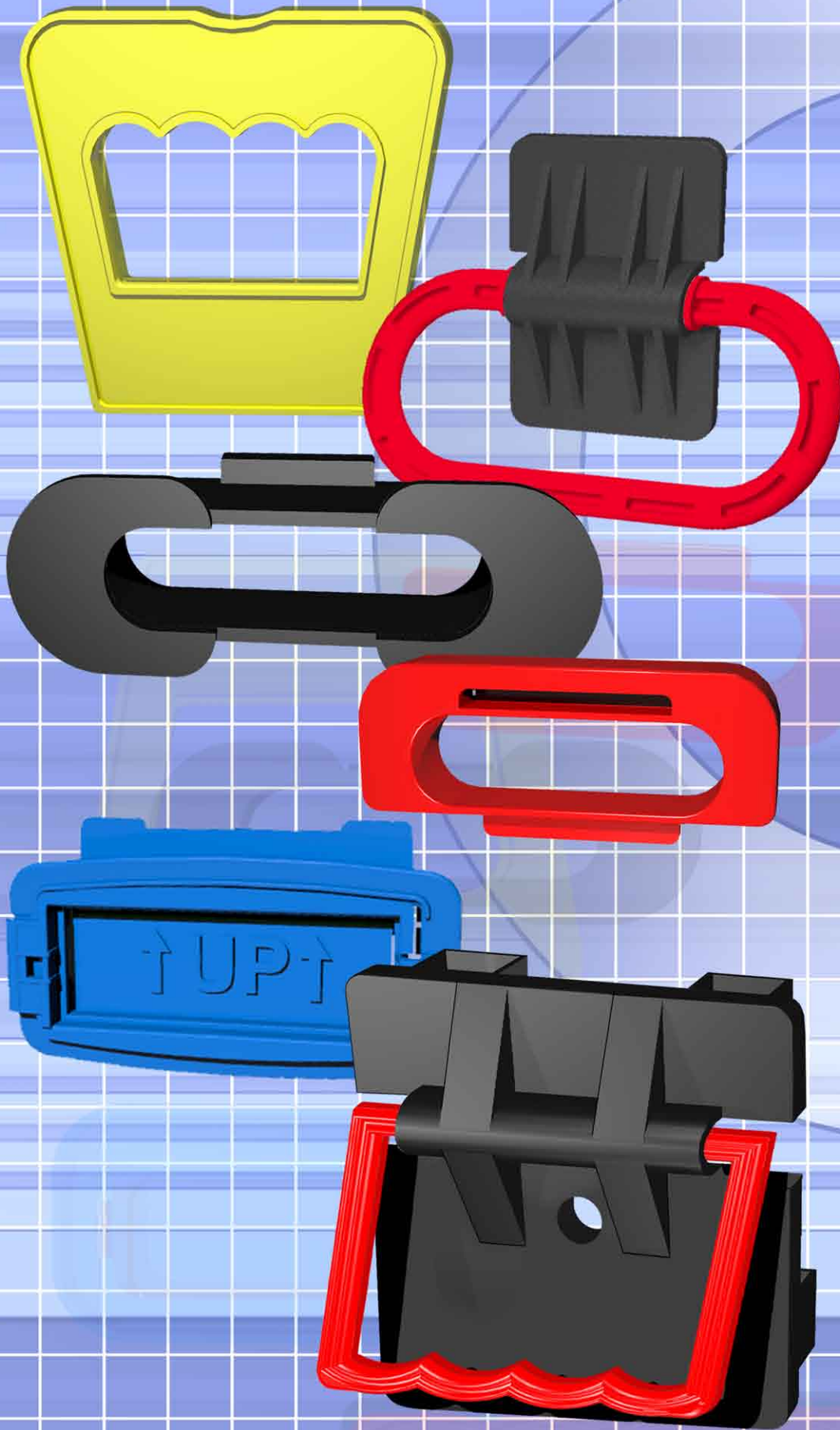

**SA
RO
FE
DO
SI
ES
E**

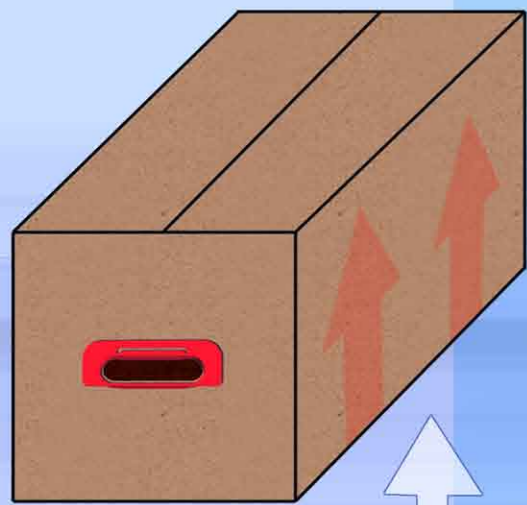

“Ranura ergonómica”
Asidero sencillo y económico.
Fácil de instalar con
el embalaje ya cerrado.

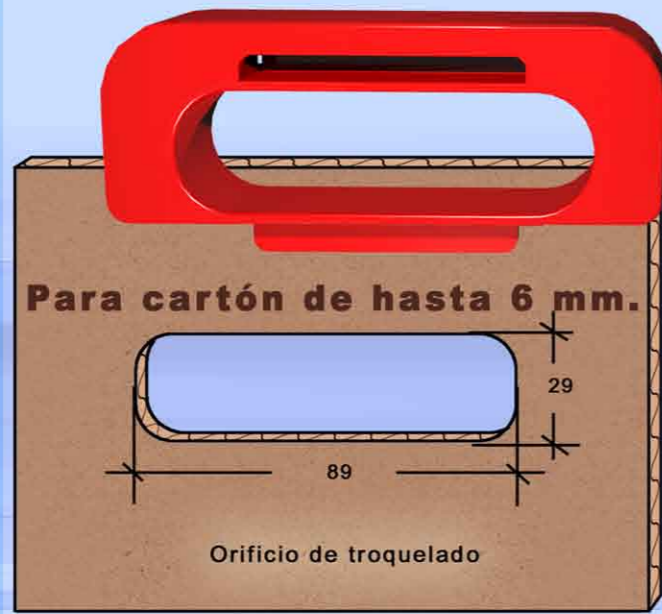

Asidero de dos piezas.
Sistema inviolable.
Colocación antes de cerrar.
Cómodo y ergonómico.
Ideal para cargas pesadas.
Posibilidad de Logotipo.

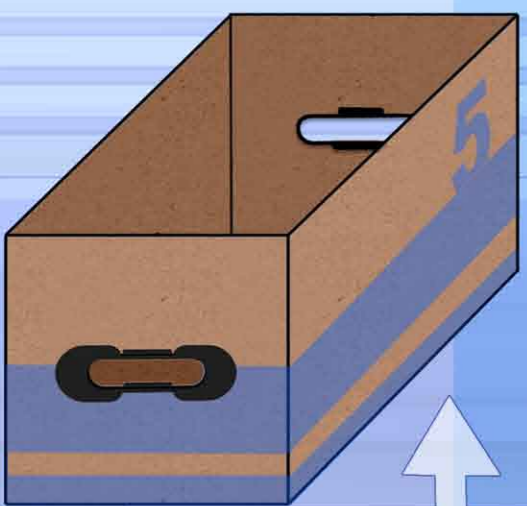
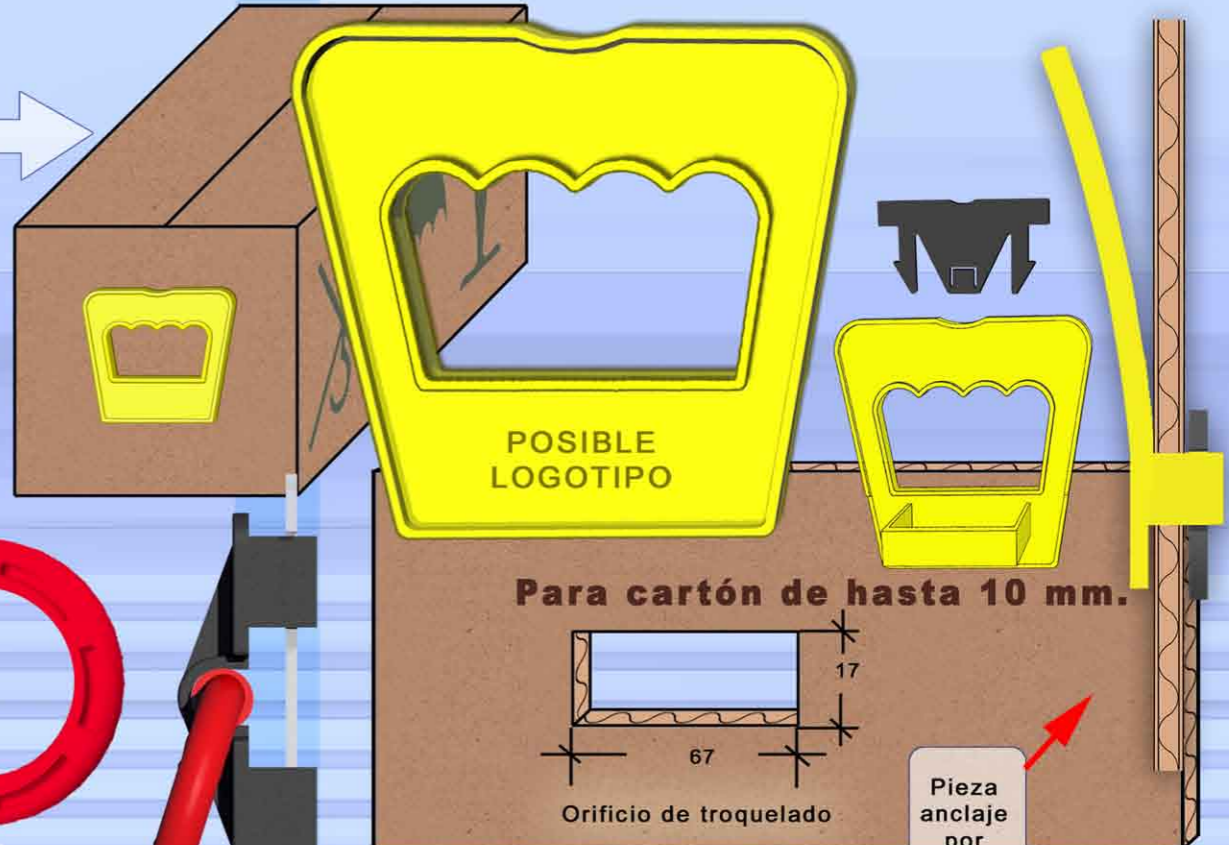

Asidero sencillo y económico.
Fácil de instalar con
el embalaje ya cerrado.

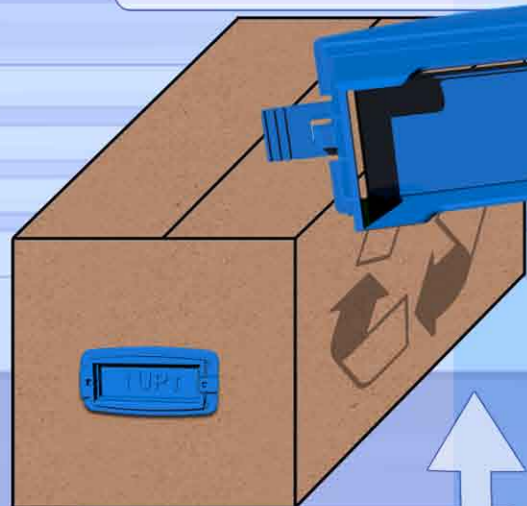
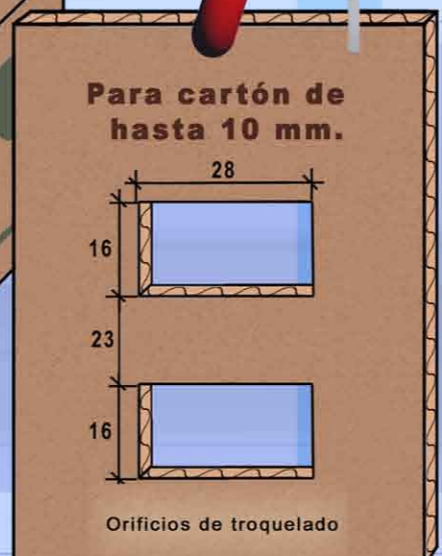
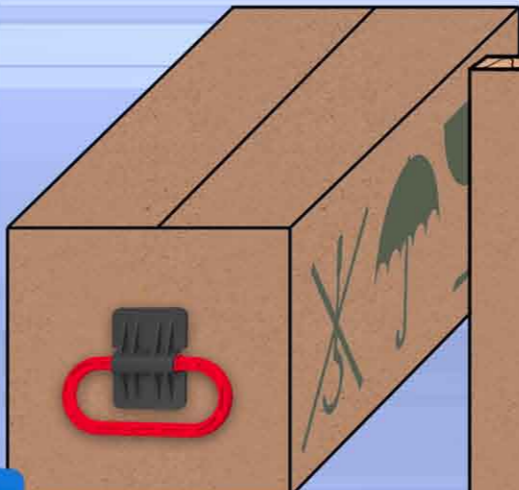
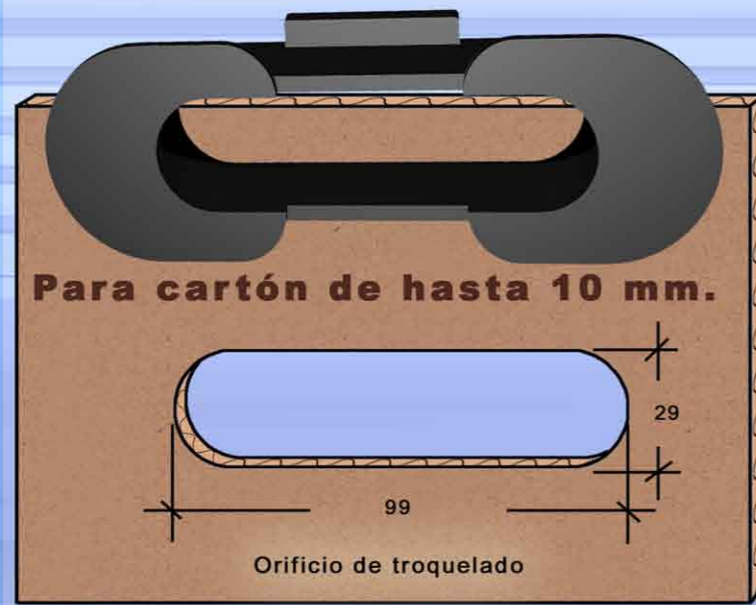

Asidero compuesto de
dos piezas unidas.
Se introduce el cuerpo
en el alojamiento y se
pliega la segunda pieza.
Tiene aleta antirratones

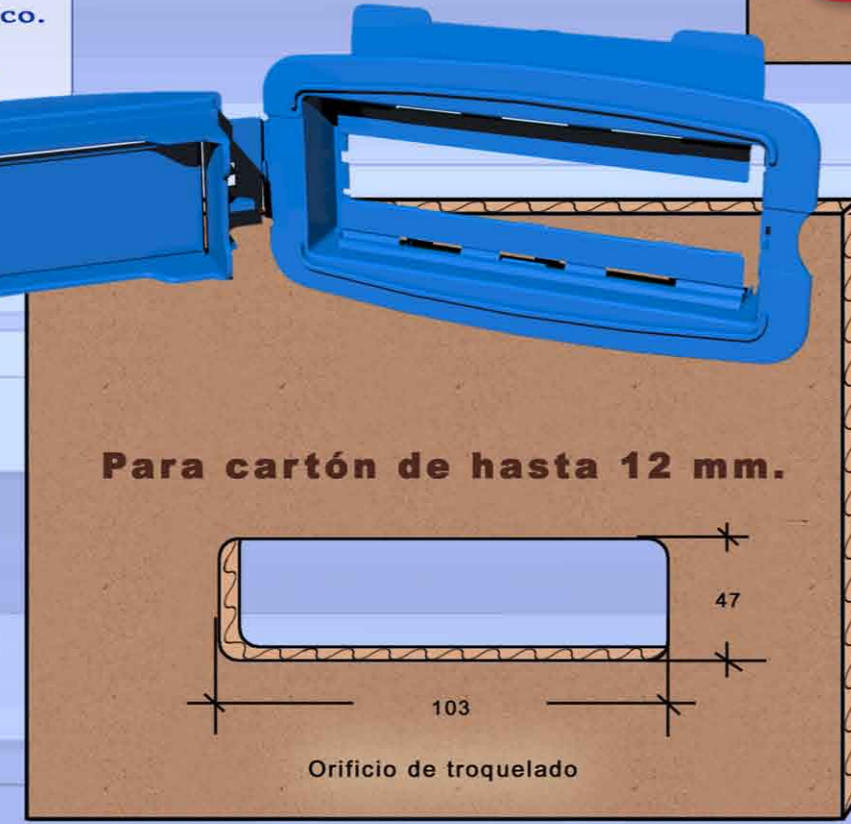

Asideros de anilla abatible.
Sujeción inviolable.
Colocación antes de cerrar.

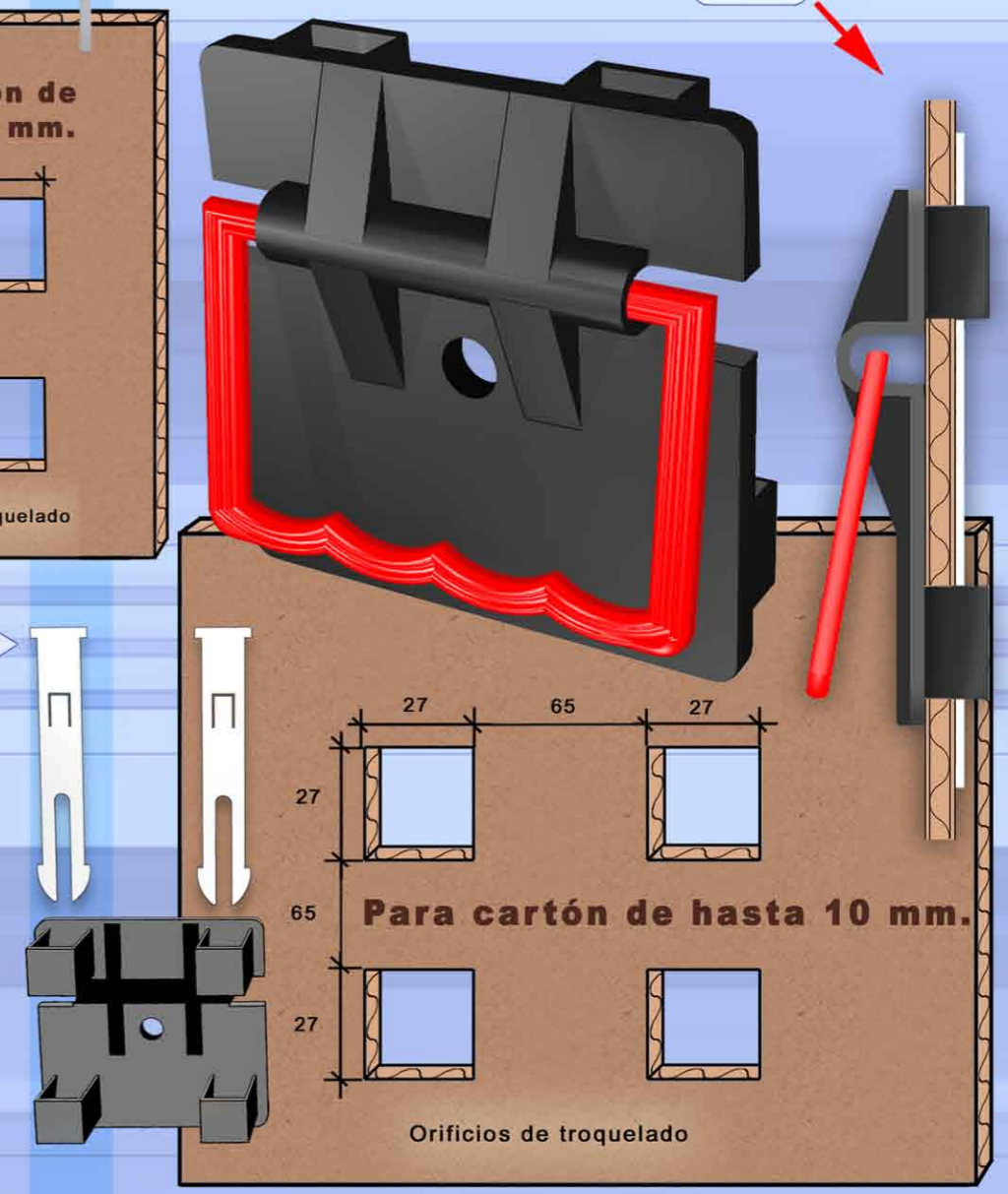
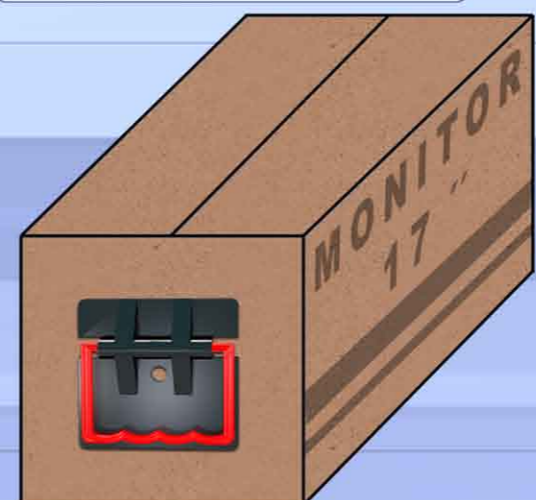



REF.
ASI-100

MATERIAL: PP
COLOR: **NEGRO**
ENVASE: 500 Uds

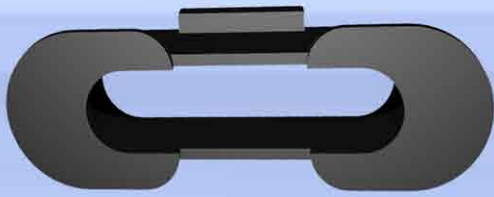

REF.
ASI-200

MATERIAL: PP
COLOR: **NEGRO**
ENVASE: 500 Uds



REF.
ASI-300

MATERIAL: PP
COLOR: **NEGRO**
ENVASE: 100 Uds

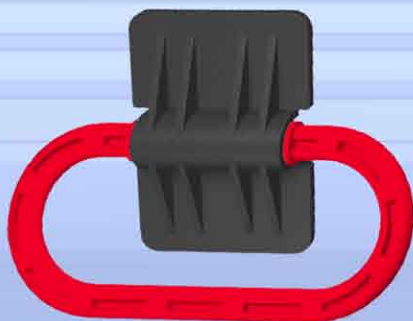

REF.
ASI-350

MATERIAL: PP
COLOR: **NEGRO**
ASA: **ROJA**
ENVASE: 100 Uds



REF.
ASI-400

MATERIAL: PP
COLOR: **NEGRO**
ENVASE: 200 Uds



REF.
ASI-500

MATERIAL: PP
COLOR: **NEGRO**
ASA: **ROJA**
ENVASE: 50 Uds



TRANSFORMACIONES PLÁSTICAS ITAL S.L.
POLÍGONO INDUSTRIAL VILLALONQUÉJAR
C/ MONTES DE OCA, Nº 9 - 09001 - BURGOS - (ESPAÑA)
TELÉFONO : 34 947 29 85 87 - FAX : 34 947 29 84 42
tpital@tpital.com www.tpital.com