



ALTRAN®

SISTEMAS PARA DECORAR CORTINAS

SOLUCIONES DECORATIVAS PARA TODOS LOS HOGARES

2019

barras de cortinas
rieles motorizados
rieles técnicos
paneles japoneses
galerías
estores
accesorios confección
rieles decorativos ■

curtain poles
motorized tracks
technical rails
sliding panels
pelmet
roman blinds
curtain accessories
decorative rails ■

tringles à rideaux
rails motorisés
rails techniques
parois japonaises
cantonnières
stores bateaux
accessoires à rideaux
rails décoratifs ■



- **Opción:**
Correderas
Option Gliders
Option Glisseurs



Wengué
Wenge



Plata Mate
Satin silver / Nickel satiné

- **Opción:**
Cinta Acordeón
Option Ruffle-tape Roll
Option Rouleau Ruban
Accordéon



Cerezo
Cherry /
Merisier

- **Opción:**
Onda Perfecta
Option Perfect Wave
Option Onde Parfaite





Blanco
White / Blanc



Negro
Black / Noir

 Riel cilíndrico que simula una elegante Barra Decorativa, diferenciándose así del resto de rieles del mercado. La colección Córcega es el resultado de la unión de dos conceptos: por fuera es una auténtica barra decorativa, mientras que por dentro, es uno de los mejores rieles del mercado, capaz de albergar Correderas Normales y/o Correderas de "Onda Perfecta" (nuestro particular y económico sistema para garantizar una caída y una onda perfecta en toda cortina). El gran diseño y estilo del Riel Córcega, incluyendo sus resistentes Soportes, transmite elegancia y sencillez, convirtiéndolo en el Riel Ideal para decorar cualquier estancia donde la estética y el diseño sean lo principal.

 Cylindrical rail made of DM simulating an elegant decorative pole. This characteristic differs from the rest of the decorative rails of the market. The Córcega collection is the result of the union of two concepts: outside is a real decorative bar and inside is one of the best rails on the market, where can be used normal gliders but also ripple fold wave gliders to make the "perfect wave" (our economic system that ensures a perfect fall and a perfect wave on every curtain). The design and style of the rail Córcega, including its strong supports, provides elegance and simplicity, making this rail ideal for the decoration of any room where aesthetics and design are the most important.

 Rail cylíndrique en DM simulant un tringle décorative et élégante. Cette caractéristique distingue ce rail du reste de rails décoratifs du marché. La collection Córcega est le résultat de l'union de deux concepts: l'extérieur est un tringle décorative et à l'intérieur a un des meilleurs rails sur le marché où peuvent être utilisés les glisseurs normales mais également les glisseurs pour ruban accordéon pour faire "l'onde parfaite" (notre système économique qui assure un tombé parfaite et une onde parfaite à chaque rideau). Le design et le style du rail Córcega, compris ses solides supports, offre élégance et simplicité, ce qui fait le rail idéal pour la décoration de toute chambre où l'esthétique et le design sont les plus importants.

Conjuntos completos con corredera standard D.07 /
 Complete sets with standard runner D.07 /
 Kits complets avec glisseur standard D.07



Incremento para Sistema Onda Perfecta / Price increase perfect wave system / Hausse prix système onde parfaite:
 D.111: 4,80 €/m D.112: 3,30 €/m D.113: 3,30 €/m D.114: 3,30 €/m

Córcega Color Wengué / Wenge / Wenge



REF					
K.724432	2	26	1	129,47 €	244
K.736632	3	38	1	182,07 €	366

Córcega Color Plata Mate / Satin Silver / Nickel Satiné



REF					
K.7244PM	2	26	1	129,47 €	244
K.7366PM	3	38	1	182,07 €	366

Córcega Color Cerezo / Cherry / Merisier



REF					
K.72449	2	26	1	129,47 €	244
K.73669	3	38	1	182,07 €	366

Córcega Color Blanco / White / Blanc



REF					
K.724422	2	26	1	129,47 €	244
K.736622	3	38	1	182,07 €	366

Córcega Color Negro / Black / Noir



REF					
K.724423	2	26	1	129,47 €	244
K.736623	3	38	1	182,07 €	366

Contenido del Kit / Kit components / Composants du Kit

 Conjuntos Sencillos (244 cm): 2 terminales, 2 soportes, perfil, tornillo tope y correderas.
 Conjuntos Sencillos (366 cm): 2 terminales, 3 soportes, tornillo tope, perfil y correderas.

 Single sets (244 cm): 2 finials, 2 brackets, track, end-stop & runners.
 Single sets (366 cm): 2 finials, 3 brackets, track, end-stop & runners.

 Kits simples (244cm): 2 embouts, 2 supports, rail, vis d'arrêt et glisseurs.
 Kits simples (366 cm): 2 embouts, 3 supports, rail, vis d'arrêt et glisseurs.

Posibilidades de montaje / Installation possibilities / Possibilités de montage



 El Riel Córcega permite combinar gracias a su soporte doble, un magnífico riel decorativo junto a un práctico riel técnico. En este ejemplo podemos ver la combinación de Riel Argent y Riel Córcega. Cualquier estancia se verá enriquecida con la elegante decoración del Riel Córcega, mientras que el Riel Argent aumenta sus posibilidades a la hora de buscar soluciones decorativas.

 The Córcega track offers the possibility of merging thanks to its special double bracket, one unique example of decorative splendor provided by the Córcega track together with the technical and practical nature of the Argent track. Any space will be enriched with the decorative elegance of the Córcega rail whereas the Argent rail will increase the possibilities regarding new decorative solutions.







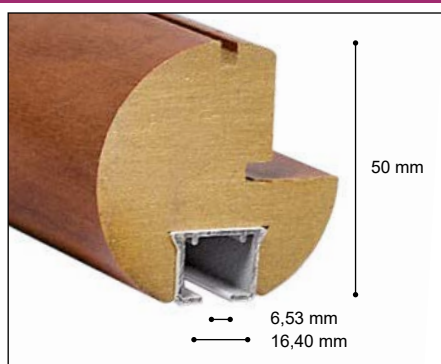

 Le rail Córcega vous permet de fusionner grâce à son support double, un exemple unique de la splendeur décorative avec un rail technique et pratique. Dans cet exemple on peut vérifier la fusion du riel Argent et Córcega. N'importe quel espace sera enrichi avec l'élégance décorative du rail Córcega, tandis que le rail Argent augmente les chances d'obtenir nouvelles solutions décoratives.

Accesorios / Accessories / Accessoires



Perfil Córcega
Córcega Profile /
Córcega Rail



REF	 -32	 -9	 -PM	 -22	 -23				
G.2244-	-32	-9	-PM	-22	-23	5	61,28 €	70,47 €	244
G.2366-	-32	-9	-PM	-22	-23	5	90,00 €	103,50€	366

Tapón Acero
Steel Finial /
Bouchon Acier



REF	∅	U	€	€	cm
D.012A		10	8,24 €	9,48 €	

Soporte Frontal
Wall Bracket /
Support Mur

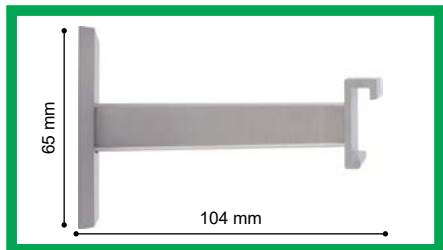

REF	∅	U	€	€	cm
N.9AS		10	16,22 €	18,65 €	

* Soporte incluido en el Kit Sencillo /
Bracket supplied in the Single Kit / Support fourni dans le Simple Kit.

Soporte Frontal
Wall Bracket /
Support Mur

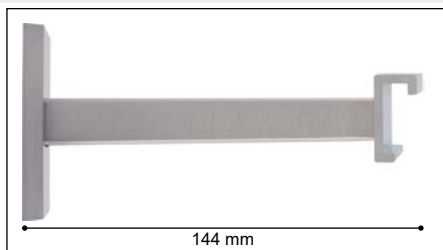

REF	∅	U	€	€	cm
N.117AS		10	18,94 €	21,78 €	

Soporte Techo
Ceiling Bracket /
Support plafond

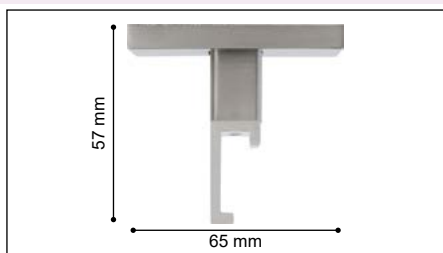

REF	∅	U	€	€	cm
N.116AS		10	17,00 €	19,55 €	

Soporte Doble
Double Wall
Bracket /
Support
Mur Double

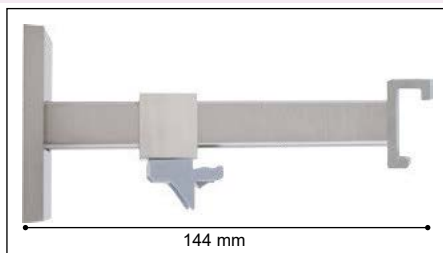

REF	∅	U	€	€	cm
O.115AS		10	23,12 €	26,59 €	

Tornillo tope
End-Stop Screw /
Vis d'arrêt



REF	∅	U	€	€	cm
D.08		1000	0,31 €	0,37 €/ud	

Corredera Maestra
Plastic Master
Runner /
Coulisse Plastic
Principal



REF	∅	U	€	€	cm
D.42		25	3,22 €	3,70 €	

Corredera
Runner /
lisseur



REF	∅	U	€	€	cm
D.07		500	0,064 €	0,077 €	

Accesorios / Accessories / Accessoires



Rollo Cinta Acordeón con Automáticos

Ruffle-tape roll with snap-buttons / Rouleau ruban accordéon avec système automat



REF	∅	U	€	€	cm
D.111		1	203,28 €	233,77 €	

* 1 rollo contiene 840 corchetes / Roll of 840 Snaps / Rouleau de 840 crochets.

Rollo Corredera Acordeón

Corded gliders roll / Rouleau glisseurs acordeón

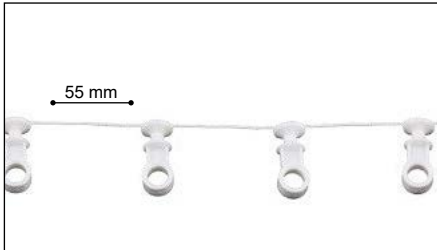

REF	∅	U	€	€	cm
D.112		1	151,20 €	173,88 €	

* 1 rollo contiene 1000 correderas / Roll of 1000 runners / Rouleau de 1000 glisseurs.

Rollo Corredera Onda Perfecta

Perfect wave runners roll / Rouleau de glisseur "onde parfaite"

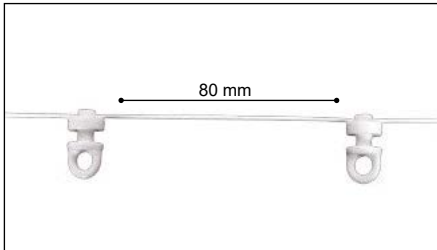

REF	∅	U	€	€	cm
D.113		1	151,20 €	173,88 €	

* 1 rollo contiene 1000 correderas / Roll of 1000 runners / Rouleau de 1000 glisseurs.

Rollo Corredera Onda Perfecta

Perfect wave runners roll / Rouleau de glisseur "onde parfaite"

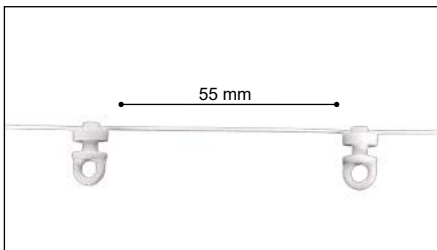

REF	∅	U	€	€	cm
D.114		1	151,20 €	173,88 €	

* 1 rollo contiene 1000 correderas / Roll of 1000 runners / Rouleau de 1000 glisseurs.

Embellecedor para empalme Córcega

Decorative joiner Córcega / Raccordeur decoratif Córcega



REF	∅	U	€	€	cm
H.09A		10	9,88 €	11,36 €	

NEW

Alargador Soporte

Bracket extender / Extendeur pour bracket



REF	∅	U	€	€	cm
R.2001AS		10	6,18 €	7,11 €	

Adaptador rieles madera

Wood track adaptador / Adapteur pour rails en bois



REF	∅	U	€	€	cm
H.28		10	2,78 €	3,20 €	

Muestra Riel Córcega

Demo Sample Córcega track / Échantillon Rail Córcega



REF	∅	U	€	€	cm
M.251		1		22,06 €	



Somos especialistas en decoración
y disponemos de múltiples soluciones para cualquier proyecto.
Descubre nuestros rieles decorativos de diseño y de calidad.

RIELES DECORATIVOS
DISEÑO PERSONAL
LA FORMA DE TENER UN HOGAR DIFERENTE



ENVÍO DE PEDIDOS

Los pedidos se realizarán indicando nuestro número de referencia y enviándolo vía fax al +34 96 113 61 27 o vía e-mail: administracion@altransolutions.es

PORTES E I.V.A

Los pedidos se expedirán a portes pagados si el importe (base imponible) supera los 150 € y el largo no exceda de 4 m. Para pedidos con largos superiores: Consultad condiciones. Para los pedidos con portes inferiores a 150€, los portes serán cargados en factura.

El I.V.A. correrá a cargo del cliente.

ANOMALÍA DEL ENVÍO

La mercancía debe revisarse delante del repartidor. Si la mercancía llega en mal estado debe notificarse en el albarán de entrega de la agencia. No sirve poner "Pendiente de Revisión", debe especificarse qué problema hay e incluso anotar si el embalaje ha llegado en mal estado.

Si no se cumple este requisito no podremos hacernos cargo de las posibles reclamaciones. Se debe dar parte de incidencia en la recepción de la mercancía **imprescindiblemente** en el **plazo NO superior a 24 horas**. Las devoluciones de mercancía deben ir acompañadas del albarán original.

DIRECCIÓN ENVÍO ESPECIAL

En caso de necesitar que la mercancía se envíe a una dirección especial diferente a la habitual, se efectuará un cargo de 5,00€ por expedición.

PRECIOS

Los precios y los productos publicados en este catálogo tiene reservado el derecho de ser modificados sin previo aviso por el fabricante.

SEGURO

La mercancía viaja por cuenta y riesgo del comprador. Si el cliente desea asegurar la mercancía, correrá por parte del cliente la prima de seguro.

RESERVA DE DOMINIO

Nuestras ventas se realizarán bajo reserva de dominio según el artículo 1506 de C.C. hasta que el valor de la mercancía se haya pagado íntegramente.

JURISDICCIÓN COMPETENTE

El comprador acepta que toda desavenencia se realizará bajo la jurisdicción de los tribunales de Valencia (España) renunciando expresamente a su propio fuero y domicilio.

ORDERS

Orders should be sent with reference number of each article. The orders can be sent by fax +34 96 113 61 27 or by mail to: export@altransolutions.es

PRICE

Prices shown are ex-works Valencia. Due to the fluctuations of the international markets beyond our control, prices and terms of sale are subject to change without prior notice.

RETURN SHIPMENTS

Returned goods will not be accepted without our prior authorization.

CLAIMS

Goods must be checked upon arrival. Claims for faulty/wrong shipments and/or shortages must be made within **3 days** of receipt of goods. Claims for transport damages must be filled against the carrier immediately upon receipt.

RIGHTS RESERVED

Our sales are always considered under the condition "Rights reserved" according to article 1506 C.C. until full payment has been settled.

VALID JURISDICTION

In case of discrepancies, disagreements or litigation, the jurisdiction of the Valencia (Spain) Courts of Law will prevail and will be accepted by the customer with waiver of his own jurisdiction of venue.

COMMANDES

Les commandes doivent être envoyées avec le numéro de référence de chaque article. Veuillez nous envoyer vos commandes par fax +34 96 113 61 27 ou par e-mail: export@altransolutions.es

PRIX

Les prix indiqués dans le catalogue sont départ d'usine (exworks). A cause des fluctuations des marchés internationaux, les prix et les conditions de vente sont sujets à changement sans préavis.

RETOUR DE MARCHANDISE

Les marchandises retournées ne seront pas acceptés sans notre autorisation préalable.

RÉCLAMATIONS

Les marchandises doivent être vérifiées à l'arrivée. Les retours erreur d'envoi ou défaut de qualité doivent être faites dans les **3 jours** suivants à la réception de la marchandise. Les réclamations pour dommages de transport doivent être remplis sur le bon de livraison du transporteur dès réception.

CLAUSE DE RÉSERVE DE PROPRIÉTÉ

Nos ventes sont toujours considérés comme la condition "Droits réservés" selon l'article 1506 CC jusqu'au paiement intégral a été réglée.

JURISDICTION COMPÉTENTE

IL'acheteur accepte qu'en cas de litige, Le tribunal compétent sois celui de Valencia (Espagne).

Una ventana está terminada cuando está decorada.



ALTRAN SOLUTIONS S.L.

Ctra Valencia-Ademuz Km 21,9
46181 Benisanó (Valencia) Spain
Telf.: 0034 96 113 61 53
Fax: 0034 96 113 61 27

VENTAS NACIONAL

administracion@altransolutions.es

INTERNATIONAL SALES

exportadm@altransolutions.es

export@altransolutions.es